



PHASE 7.3 COIN USER'S MANUAL

American Dryer Corporation
88 Currant Road
Fall River, MA 02720-4781
Telephone: (508) 678-9000 / Fax: (508) 678-9447
E-mail: techsupport@amdry.com
www.amdry.com

Retain This Manual In A Safe Place For Future Reference

Please read this manual carefully to thoroughly familiarize yourself with the Phase 7 Coin computer system features, operational instructions, and programming characteristics. This manual contains important information on how to employ ALL the features of your new **ADC** dryer in the safest and most economical way.

American Dryer Corporation products embody advanced concepts in engineering, design, and safety. If this product is properly maintained, it will provide many years of safe, efficient, and trouble-free operation.

We have tried to make this manual as complete as possible and hope you will find it useful. **ADC** reserves the right to make changes from time to time, without notice or obligation, in prices, specifications, colors, and material, and to change or discontinue models.

“IMPORTANT NOTE TO PURCHASER”

Information **must be** obtained from your local gas supplier on the instructions to be followed if the user smells gas. These instructions **must be** posted in a prominent location near the dryer.

IMPORTANT

YOU MUST DISCONNECT AND LOCKOUT THE ELECTRIC SUPPLY AND THE GAS SUPPLY OR THE STEAM SUPPLY BEFORE ANY COVERS OR GUARDS ARE REMOVED FROM THE MACHINE TO ALLOW ACCESS FOR CLEANING, ADJUSTING, INSTALLATION, OR TESTING OF ANY EQUIPMENT PER OSHA (Occupational Safety and Health Administration) STANDARDS.

FOR YOUR SAFETY

DO NOT STORE OR USE GASOLINE OR OTHER FLAMMABLE VAPORS AND LIQUIDS IN THE VICINITY OF THIS OR ANY OTHER APPLIANCE.

DO NOT DRY MOP HEADS IN THE DRYER.

DO NOT USE DRYER IN THE PRESENCE OF DRY CLEANING FUMES.

CAUTION

DRYERS SHOULD NEVER BE LEFT UNATTENDED WHILE IN OPERATION.

WARNING

CHILDREN SHOULD NOT BE ALLOWED TO PLAY ON OR NEAR THE DRYERS.

CHILDREN SHOULD BE SUPERVISED IF NEAR DRYER(S) IN OPERATION.

WARNING

The dryer *must never be* operated with any of the back guards, outer tops, or service panels removed. PERSONAL INJURY OR FIRE COULD RESULT.

WARNING

DRYER MUST NEVER BE OPERATED WITHOUT THE LINT FILTER OR SCREEN IN PLACE, EVEN IF AN EXTERNAL LINT COLLECTION SYSTEM IS USED.

IMPORTANT

PLEASE OBSERVE ALL SAFETY PRECAUTIONS displayed on the equipment and specified in the installation manual included with the dryer.

Dryers **must not be** installed or stored in an area where it **will be** exposed to water or weather.

The wiring diagram for the dryer is located in the front electrical control box area.

WARNING

Power **must be** disabled prior to changing S.A.F.E. System temperature probe!! The S.A.F.E. System **will be** activated if probe is removed while dryer is powered on.

NOTE

If power to the dryer is off, the S.A.F.E. System is disabled.

Table of Contents

SECTION I	
INTRODUCTION	3
SECTION II	
FEATURES	4
A. Dependable Microprocessor Solid State Integrated Circuitry	4
B. Sensor Activated Fire Extinguishing (S.A.F.E.) System	4
C. Program Changes are Easily Made at the Keyboard (Touch Pad)	4
D. Temperature Selections	4
E. Cool Down	4
F. Liquid Crystal Display (L.C.D.)	4
G. Anti-Wrinkle Program	4
H. Diagnostics	4
I. Audio Alert Signal	4
J. Temperature Conversion Status	4
K. High-Temperature Protection	4
L. RPM	4
M. Clean Lint	4
N. Language Selection	5
O. Model Selection	5
P. Keyboard (Touch Pad) Symbols	5
Q. Currency Selection	5
R. Dry Mode	5
S. Vending Safeguard	5
T. Credit Retention	5
SECTION III	
OPERATING INSTRUCTIONS	6
A. Coin Mode	
Hot Keys-Remaining Credit, Temp, RPM	6
B. Free Mode	
Hot Keys-Remaining Credit, Temp, RPM	6
C. Pause Mode	7
D. RPM	7
E. Clearing Credit	7
F. Accessing Coin Vault	7
SECTION IV	
L.C.D. OPERATING MESSAGES	8
A. Coin Mode	8
B. Free Mode	8
C. Messages Common to Coin and Free Mode	9

SECTION V

PROGRAM SELECTIONS (PL01-PL14)	10
PL01 Select Language	10
PL01 Select Currency	10
PL01 Select Model	10
PL01 Select Temp Scale	10
PL01 Select Buzzer Mode	10
PL01 Select Dry Mode	11
PL01 Select Vending Safeguard	11
PL01 Select Vending Mode	11
PL01 Select Rotation Sensor Mode	14
PL02, PL04, PL06 High, Low, Permanent Press Cycle Dry Temp.	14
PL03, PL05, PL07 High, Low, Permanent Press Cycle Cool Time	15
PL08, PL09 Left/Right Coin Denomination	15
PL10 Time for Amount to Start	15
PL11 Amount to Start	15
PL12 Amount for Additional Time	16
PL13 Prepurge Time	16
PL13 DSI Purge Time	16
PL13 DSI Proof Time	16
PL13 Buzz Time	16
PL13 Pause Time	16
PL14 Lint Cleaning Frequency	16
PL14 Retry Count	16
Anti-Wrinkle Program	17
Sensor Activated Fire Extinguishing (S.A.F.E.) System	17

SECTION VI

PROGRAMMING INSTRUCTIONS	18
A. Introduction to Programming	18
B. Program Location Summary	19
C. Programming Flowcharts	20
D. Flowchart Table of Contents	21

SECTION VII

FACTORY PRESETS	54
------------------------------	-----------

SECTION VIII

PHASE 7 COIN SYSTEM DIAGNOSTICS	55
A. Diagnostic (L.C.D.) Fault Messages	55
B. Sensor Activated Fire Extinguishing (S.A.F.E.) System Diagnostic Messages	58
C. Input/Output (I/O) Board Light Emitting Diode (L.E.D.) Indicators	59
D. Keyboard (Touch Pad) Layout	60

SECTION I

INTRODUCTION

Phase 7 “Coin” Microprocessor Drying System

American Dryer Corporation’s Phase 7 Coin Drying System has been designed with super performance in mind to provide for better temperature regulation, efficiency, performance, consistency, and faster drying times.





Utilizing this microprocessor technology, the user simply has to place the load in the dryer, insert credit, and push one (1) button to start the drying cycle.

The Phase 7 coin microprocessor provides a very simple user interface, while simultaneously implementing state-of-the-art technology to ensure safety and performance. The Phase 7 coin control constantly monitors the dryer and **ALL** systems to ensure proper functionality and eliminates **ALL** guesswork in the maintenance of the dryer.

SECTION II

FEATURES

- A. **Dependable Microprocessor Solid State Integrated Circuitry** - To eliminate as many moving parts as possible.
- B. **Sensor Activated Fire Extinguishing (S.A.F.E.) System** - A feature which continually monitors the basket (tumbler) for fires. In the event of a fire, a water supply to the basket (tumbler) will suppress the fire. The Phase 7 coin microprocessor controller (computer) will also notify the user that a fire has taken place.
- C. **Program Changes are Easily Made at the Keyboard (Touch Pad)** - Actual programs are viewed at the liquid crystal display (L.C.D.) for verification.
- D. **Temperature Selections** - Accommodates 3 temperature settings: “HI,” “PP,” and “LO,” each programmable to a drying temperature between 100° F (38° C) and 190° F (87° C) for radial airflow or 100° F (38° C) and 160° F (71° C) for axial airflow.
- E. **Cool Down** - Cool down lowers the temperature in the basket (tumbler) to make the material cool enough to handle.
- F. **Liquid Crystal Display (L.C.D.)** - Informs user of cycle status and programs; displays important diagnostic and fault codes.
- G. **Anti-Wrinkle Program** - Helps keep items wrinkle-free when they are not removed from the dryer promptly at the end of the drying and cooling cycles.
- H. **Diagnostics** - Major circuits, including the door switch(es), microprocessor temperature sensor, heat output circuits, and more are individually monitored, allowing for precise messages of your failure.
- I. **Audio Alert Signal** - The tone will sound at the end of a complete drying cycle at a 1-second rate for the duration programmed. It will also sound for any fault conditions at a quarter-second rate for four (4) beeps. Finally there is a 3-beep warning at the beginning of every Anti-Wrinkle On Cycle, and a continuous rapid pulse is used for the entire duration of S.A.F.E. system activation.
- J. **Temperature Conversion Status** - Temperature-related programs can be set in either Fahrenheit (°F) or Celsius (°C). **ALL** temperatures will automatically convert to the corresponding values (+/- 1°) when changes are made.
- K. **High-Temperature Protection** - If the Phase 7 coin microprocessor controller (computer) senses that the temperature in the basket (tumbler) has exceeded 180° F (82° C) for axial airflow or 210° F (98° C) for radial airflow, it will end the drying cycle, and a fault code will be displayed indicating an overheating problem.
- L. **RPM** - The Phase 7 coin microprocessor controller (computer) monitors the speed of the basket (tumbler) rotation.
- M. **Clean Lint** - This feature notifies the user when the lint access **should be** cleaned.

- N. **Language Selection** - Phase 7 coin microprocessor controller (computer) has the ability to display six (6) different languages: English, French, Spanish, Italian, Japanese and Dutch.
- O. **Model Selection** - The Phase 7 coin microprocessor controller (computer) can be programmed to be used on six (6) different model dryers, defined by heat type and the quantity of motors.
- P. **Keyboard (Touch Pad) Symbols** -  = "PAUSE/CLEAR" key
 = "PP/ENTER" key
 = "HI/UP" key (scroll up)
 = "LO/DOWN" key (scroll down)
- Q. **Currency Selection** - The Phase 7 coin microprocessor controller (computer) can be programmed to display **ALL** currency in one of the following seven (7) currency symbols.
 USD/ UK Pound/ Euro/ Belgium Franc/ French Franc/ Yen/ Lira
- R. **Dry Mode** - The Phase 7 coin microprocessor controller (computer) can be programmed to operate in either coin mode or free dry mode.
- S. **Vending Safeguard** - This feature provides protection against counterfeit coins.
- T. **Credit Retention** - In the event that the Phase 7 controller experiences a power loss, the controller will automatically retain the amount of remaining credit that a customer had at the time of the power loss. When power is restored, the Phase 7 controller will prompt the user to select a temp cycle, and will vend the appropriate amount of time according to the amount of remaining credit that was present at the time of the power loss.

SECTION III

OPERATING INSTRUCTIONS

A. COIN MODE

1. When the controller is in the ready state and no cycle is in progress, the liquid crystal display (L.C.D.) screen will read “Ready, Insert \$XX.XX to Start.”
2. Insert coin(s). Once the correct “Amount to Start” has been inserted, the L.C.D. will display “Select Temperature.”
3. Select temperature by pressing “HI,” “PP,” or “LO.” The cycle will start, and the L.C.D. will display the Dry Cycle selected and the remaining time.
4. The dryer will continue through the drying and cooling cycles until the vended time has expired.
5. Upon completion of drying and cooling cycles the buzzer will sound, and the dryer will go into Anti-Wrinkle mode for 99 minutes or until the door has been opened.
6. HOT KEYS - When the control is in coin mode, the HOT KEYS are disabled. The HOT KEYS can be enabled only if the dryer is in a dry cycle. The HOT KEYS cannot be enabled if the dryer is in “Ready, Insert 25¢ to Start” mode. To enable the HOT KEYS when the controller is in a dry cycle, toggle the program switch to the “UP” position. Once the program switch is in the “UP” position, the HOT KEYS are enabled. The HOT KEYS are as follows:

Pressing and holding the “HI” key will show the remaining credit available.

Pressing and holding the “PP” key will show the temperature readings of the exhaust temperature transducer and the FSS temperature probe. The exhaust temperature reading is displayed on the left, and the FSS temperature reading is on the right. If the dryer is an axial model, the temperature reading of the axial temperature transducer will also be displayed; this will be the middle temperature reading.

Pressing and holding the “LO” key will show the RPMs of the basket (tumbler).

The “PAUSE” key will pause the dryer. If the dryer is paused, pressing the “HI,” “PP,” or “LO” key will restart the dryer into the appropriate drying cycle. Once the dry cycle has started again, the HOT KEYS will be enabled again.

B. FREE MODE

1. When the controller is in the ready state and no cycle is in progress, the L.C.D. screen will display “Select Temperature.”
2. Select temperature by pressing “HI,” “PP,” or “LO.” The cycle will start and the controller will display the Dry Cycle selected and the remaining time.
3. The dryer will continue through the drying and cooling cycles, until the drying time has expired.

4. Upon completion of the drying and cooling cycles, the buzzer will sound, and the dryer will go into Anti-Wrinkle mode for 99 minutes or until the door has been opened.
5. HOT KEYS - In free mode, the HOT KEYS are always enabled. The HOT KEYS are as follows:

Pressing and holding the “HI” key will show the remaining dry time available.

Pressing and holding the “PP” key will show the temperature readings of the exhaust temperature transducer and the FSS temperature probe. The exhaust temperature reading is displayed on the left and the FSS temperature reading is on the right. If the dryer is an axial model, the temperature reading of the axial temperature transducer will also be displayed, this will be the middle temperature reading.

Pressing and holding the “LO” key will show the RPMs of the basket (tumbler).

The “PAUSE” key will pause the dryer. If the dryer is paused, pressing the “HI,” “PP,” or “LO” key will restart the dryer into the appropriate drying cycle. Once the dry cycle has started again, the HOT KEYS will be enabled again.

C. PAUSE MODE

If the “PAUSE” key is pressed and the door is not opened, the dryer will restart in 20-seconds. If the dryer door is opened and left open, the dryer will wait for the pause time defined in PL13 to expire. Once the pause time expires, the controller will begin to count down the dry time.

D. RPM

The Phase 7 microprocessor controller also displays the basket (tumbler) RPM by pressing and holding the “LO” key while the basket (tumbler) is rotating (the basket [tumbler] **must be** rotating for approximately 30-seconds before getting a true RPM reading). In coin mode, the program switch **must be** in the “UP” position.

E. CLEARING CREDIT

Credit can be cleared from the Phase 7 controller by using the following key combination. With the program switch down, press and hold the “PAUSE” key while entering the following key combination. “HI-HI-HI-LO-LO-PP” The combination is the “HI” key three (3) times followed by the “LO” key two (2) times and then the “PP” key one (1) time. Wait 1-second for the control to prompt the user with “Clear Credit?” If you want to proceed, simultaneously press the “PAUSE” button and one of the remaining keys. This will clear the credit. A flowchart of this procedure has been provided in Section VI of this manual.

F. ACCESSING COIN VAULT

The coin vault can be accessed by placing the program switch into the “UP” position. Once the program switch is in the “UP” position, press the “HI” key. The controller will now display the amount of money in the coin vault. Press the “HI” key again and the controller will ask to “Clear Coin Vault Total?” Press “PAUSE” for “NO” and press “PP” for “YES.”

SECTION IV

L.C.D. OPERATING MESSAGES

The liquid crystal display (L.C.D.) informs the operator of cycle status and program verification and displays important diagnostic messages and fault information.

A. COIN MODE

When the dryer is idle and is in “Ready” mode the Phase 7 coin microprocessor will display:

Ready, Insert \$XX.XX to Start

XX.XX represents the amount to start defined in program memory location PL11. If the amount to start is less than \$1.00, the control will display the necessary amount to start in cents “XX¢.” If the currency setting is changed to another currency symbol, the correct symbol will be used instead of the \$ and ¢ symbols.

If dryer is equipped with a Sensor Activated Fire Extinguishing (S.A.F.E.) System and there is an issue with the system, the control will display:

S.A.F.E. System Disabled...Ready, Insert \$XX.XX to Start

The control will continue to display S.A.F.E. System disabled with **ALL** of the following messages until the temp cycle is selected.

Once a coin has been inserted, the control will display:

Add XX¢ to Start or S.A.F.E. System Disabled...add XX¢ to Start

The control will continue to display this message until the appropriate amount to start has been met. Then the control will display:

Select Temperature or S.A.F.E. System Disabled...Select Temperature

<p>NOTE: When “S.A.F.E. System Disabled...” is displayed, the specific cause can be viewed by pressing “PAUSE” an “LO” together.</p>

In coin mode, if the control detects a malfunction, it will display:

Out of Order

To see the error fault, press “LO,” and the fault will be displayed. Refer to **Section VIII** for a complete list of faults and descriptions.

B. FREE MODE

If control is in free mode and is in a ready state, the control will display:

Select Temperature

Likewise if the dryer is equipped with a Sensor Activated Fire Extinguishing (S.A.F.E.) System and there is an issue with the system, the control will display:

S.A.F.E. System Disabled...Select Temperature

If a malfunction is detected in free mode, the fault will be displayed. Refer to **Section VIII** for complete list of faults and descriptions.

C. MESSAGES COMMON TO COIN AND FREE MODE

Once a dry cycle has been selected, regardless of coin or free mode, the control will toggle between the following two messages:

One of the following messages depending on the cycle selected:

- A. **Low Dry Temperature**
High Dry Temperature
Permanent Press Temperature

And one of the following messages depending on time remaining:

- B. **XX:XX minutes remaining**
00:XX seconds remaining

If the dryer is paused, the control will display:

Cycle Paused...

If the door is opened, the control will display:

Main Door Open

If the main door is open, and a dry cycle is selected, the control will display:

Close Main Door

If the lint access is opened, the control will display:

Lint Access Open

If the lint access door is open, and a dry cycle is selected, the control will display:

Close Lint Access

SECTION V

PROGRAM SELECTIONS (PL01-PL14)

PL01-Program Location

Select Language

This location determines in what language **ALL** messages will be displayed. The possible selections are English, French, Spanish, Italian, Japanese, and Dutch.

Select Currency

This location determines what currency symbol will be used on **ALL** currency-related messages. Possible selections are USD, UK Pound, Euro, Belgium Franc, French Franc, Yen, and Lira.

Select Model

This location determines what type of dryer the controller will be set up as. The six possible models are Gas Single Motor, Electric Single Motor, Steam Single Motor, Gas Dual Motor, Electric Dual Motor and Steam Dual Motor.

NOTE: In the event that the wrong model is selected, the control will go into a models fault and will default to a Gas Single Motor dryer.

Select Temp Scale

Temperature-related programs are programmable to be operated in either Fahrenheit (°F) or Celsius (°C). The temperature scale selection is made in “PL01 TEMP SCALE.” Programs affected are:

1. Temperature Display Mode
2. Drying Temperatures
3. Cool Down Temperatures

IMPORTANT: When changing the temperature conversion status from Fahrenheit to Celsius or vice versa, **ALL** the temperatures will be changed accordingly. The Phase 7 coin microprocessor controller (computer) automatically calculates and converts the temperatures in these programs to the previously set value. For example, when changing from °F to °C, if the drying temperature was set for 160° F, the Phase 7 coin microprocessor controller (computer) will change to 71° C (+/- [1] one-degree Celsius).

Select Buzzer Mode

This location determines whether the buzzer will sound at the end of each Anti-Wrinkle cycle. This option is toggled ON/OFF. See the Anti-Wrinkle description at the end of this section for an explanation of Anti-Wrinkle functionality.

Select Dry Mode

This option determines whether the dryer operates in free mode or coin mode.

Select Vending Safeguard

The controller can be set to one of the following safeguards.

Bad Coin Reset - When this option is selected and someone tampers with the coin acceptor or inserts a foreign object, the controller will beep three (3) times and will not accept the entry and will display “Bad Coin Reset”. The controller will automatically reset itself for the next entry.

Bad Coin Lockout - When this option is selected and someone tampers with the coin acceptor or inserts a foreign object, the controller will lockout and will not accept any coins for a period of 15-seconds and will display “Bad Coin Lockout”. After 15-seconds the controller will reset itself for the next entry.

Select Vending Mode

Vending mode determines how the controller will vend time to a customer when a coin is inserted into the dryer. The controller uses this parameter to determine whether the controller is in Accumulative Time or Accumulative Coin mode. Depending on which mode the controller is in it will use a combination of the following program locations to determine how much time will be vended to the customer.

- PL #08 - Left Coin Denomination**
- PL #09 - Right Coin Denomination**
- PL #10 - Time for Amount to Start**
- PL #11 - Amount to Start**
- PL #12 - Amount for Additional Time**

Accumulative Time -

In accumulative time mode, after the initial “Amount to Start” (PL #11) has been met each additional coin afterward will have a specific value in time, which is determined by “Time for Amount to Start” (PL #10) and “Amount to Start” (PL #11).

Single Coin Acceptor -

Example No. 1: If the dryer is equipped with a 25¢ coin acceptor and the “Amount to Start “ (PL #11) is 25¢ and the “Time for Amount to Start” (PL #10) is 30 minutes. Each coin entered into the dryer will yield 30 minutes.

Settings: PL #08 25
PL #10 30
PL #11 25

Formula: (Left Coin Denomination [PL #08] / Amount to Start [PL #11])
(Time for Amount to Start [PL #10]) = Vended Time
(25¢/25¢)(30) = 30 minutes

Example No. 2: If the dryer is equipped with a 25¢ coin acceptor and the “Amount to Start “ (PL #11) is 50¢ and the “Time for Amount to Start” (PL #10) is 30 minutes. The insertion of the first two coins into the dryer will yield 30 minutes, each additional coin entered into the dryer will yield 15 minutes.

Settings: PL #08 25
PL #10 30
PL #11 50

Formula: (Left Coin Denomination [PL #08] / Amount to Start [PL #11])
 (Time for Amount to Start [PL #10]) = Vended Time
 $(50¢/50¢)(30) = 30$ minutes
 $(25¢/50¢)(30) = 15$ minutes

Dual Coin Acceptor-

Example No. 1: If the dryer is equipped with a 10¢/ 25¢ dual coin acceptor and the “Amount to Start “ (PL #11) is 25¢ and the “Time for Amount to Start” (PL #10) is 15 minutes. After the initial “Amount to Start” (PL #11) has been met each additional 10¢ will yield 6 minutes and each additional 25¢ will yield 15 minutes.

Settings: PL #08 10
PL #09 25
PL #10 15
PL #11 25

Formula: (Left Coin Denomination [PL #08] / Amount to Start [PL #11])
 (Time for Amount to Start [PL #10]) = Vended Time
 $(10¢/25¢)(15) = 6$ minutes

(Right Coin Denomination [PL #08] / Amount to Start [PL #11])
 (Time for Amount to Start [PL #10]) = Vended Time
 Right Coin- $(25¢/25¢)(15) = 15$ minutes

Example No. 2: If the dryer is equipped with a 10¢/ 25¢ dual coin acceptor and the “Amount to Start “ (PL #11) is 35¢ and the “Time for Amount to Start” (PL #10) is 14 minutes. After the initial “Amount to Start” (PL #11) has been met each additional 10¢ will yield 4 minutes and each additional 25¢ will yield 10 minutes.

Settings: PL #08 10
PL #09 25
PL #10 14
PL #11 35

Formula: (Left Coin Denomination [PL #08] / Amount to Start [PL #11])
 (Time for Amount to Start [PL #10]) = Vended Time
 $(10¢/35¢)(14) = 4$ minutes

(Right Coin Denomination [PL #08] / Amount to Start [PL #11])
 (Time for Amount to Start [PL #10]) = Vended Time
 $(25¢/35¢)(14) = 10$ minutes

NOTE: If the vend time cannot be divided evenly by the “Amount to Start”, the “Time for Amount to Start” will calculate precisely the amount of time entitled to the purchaser.

Accumulative Coin -

In accumulative coin mode, additional time can only be achieved when the “Amount for Additional Time” (PL #12) has been inserted.

Single Coin Acceptor -

Example No. 1: If the dryer is equipped with a 25¢ coin acceptor and the “Amount to Start “(PL #11) is 50¢, “Amount for Additional Time” (PL #12) is 50¢ and the “Time for Amount to Start” (PL #10) is 24 minutes. Each additional two (2) coins entered into the dryer will yield 24 minutes, no time will be vended if only one (1) coin is inserted.

Settings: PL #08 25
PL #10 24
PL #11 50
PL #12 50

Formula: (Amount for Additional Time [PL #12] / Amount to Start [PL #11])
 (Time for Amount to Start [PL #10]) = Vended Time for “Amount for Additional Time (PL #12)
 (50¢/50¢)(24) = 24 minutes

Example No. 2: If the dryer is equipped with a 25¢ coin acceptor and the “Amount to Start “ (PL #11) is 50¢, “Amount for Additional Time” (PL #12) is 25¢ and the “Time for Amount to Start” (PL #10) is 24 minutes. After the amount to Start” (PL #11) has been met, each additional coin entered into the dryer will yield 12 minutes.

Settings: PL#08 25
PL#10 24
PL#11 50
PL#12 25

Formula: (Amount for Additional Time [PL #12] / Amount to Start [PL #11])
 (Time for Amount to Start [PL #10]) = Vended Time for “Amount for Additional Time (PL #12)
 (50¢/50¢)(24) = 24 minutes
 (25¢/50¢)(24) = 12 minutes

Dual Coin Acceptor -

Example No. 1: If the dryer is equipped with a 10¢/ 25¢ dual coin acceptor and the “Amount to Start “ (PL #11) is 50¢, the “Amount for Additional Time” (PL #12) is 20¢ and the “Time for Amount to Start”(PL #10) is 20 minutes. After the initial “Amount to Start” (PL #11) has been met each additional 20¢ will yield 8 minutes and each additional 25¢ will yield 8 minutes with 5¢ left in escrow. Each time a 25¢ coin is inserted the remaining 5¢ will be added to escrow, once the amount in escrow reaches 20¢ another 8 minutes will be vended.

Settings: PL #08 10
PL #09 25
PL #10 20
PL #11 50
PL #12 20

Formula: (Amount for Additional Time [PL #12] / Amount to Start [PL #11])
 (Time for Amount to Start [PL #10]) = Vended Time for “Amount for Additional Time(PL #12)
 (20¢/50¢)(20) = 8 minutes

(Amount for Additional Time [PL #12] / Amount to Start [PL #11])
 (Time for Amount to Start [PL #10]) = Vended Time for “Amount for Additional Time (PL #12)
 (20/50¢)(20) = 8 minutes with 5¢ in escrow.

Example No. 2: If the dryer is equipped with a 10¢/ 25¢ dual coin acceptor and the “Amount to Start
 “(PL #11) is 50¢, the “Amount for additional Time” (PL #12) is 50¢ and the “Time for Amount
 to Start” (PL #10) is 20 minutes. After the initial “Amount to Start” (PL #11) has been met
 each additional 50¢ will yield 20 minutes.

Settings: PL #08 10
PL #09 25
PL #10 20
PL #11 50
PL #12 50

Formula: (Left Coin Denomination [PL #08] / Amount to Start [PL #11])
 (Time for Amount to Start [PL #10]) = Vended Time
 (50¢/50¢)(20)= 20 minutes

(Right Coin Denomination [PL #08] / Amount to Start [PL #11])
 (Time for Amount to Start [PL #10]) = Vended Time
 (50¢/50¢)(20) = 20 minutes

Select Rotation Sensor Mode

This option controls whether the Phase 7 microprocessor controller (computer) should monitor the rotation of the basket (tumbler). This program location toggles ON/OFF.

PL02 (HI), PL04 (LO), PL06 (PP)-Program Locations Cycle Dry Temp.

Enter High Dry Temp 100° F to 190° F

Each temperature cycle “HI,” “PP,” and “LO” can be programmed to a dry temperature ranging from 100° F to 190° F (38° C to 87° C) in radial mode or 100° F to 160° F (38° C to 71° C) in axial mode.

PL03 (HI), PL05 (LO), PL07 (PP)-Program Locations Cycle Cool Temp and Time

Enter High Cool Temp 70° F to 100° F

Each temperature cycle “HI,” “PP,” and “LO” has a cool down temperature ranging from 70° F to 100° F (21° C to 38° C). Once the dryer enters the cool down mode, the dryer will operate without heat until the temperature in the basket (tumbler) has reached this set temperature or until the cool down time has expired, whichever comes first.

Enter Cool Time 0 to 9 minutes

Cool down time ranges from 0 to 9 minutes. The cool down time occurs at the end of a dry cycle. If your cool down time is set to 4 minutes, the last 4 minutes of the dry cycle will be in cool down mode.

PL08 (Left), PL09 (Right)-Program Locations Left/Right Coin Denomination

Enter Left/Right Coin Denomination 0.05 to 25.00

The left and right coin acceptors can be independently set to a value within the range of 0.05 to 25.00, adjustable in 0.01 increments.

PL10-Program Location

Enter Time for Amount to Start 1 to 99 minutes

This location determines the time that is vended once the amount to start is met. This is programmable from 1 minute to 99 minutes in 1 minute increments.

PL11-Program Location

Amount to Start

This location determines the amount needed to start a dry cycle. The amount to start is programmable from a minimum of 0.05 to a maximum of 25.00, adjustable in 0.01 increments.

PL12-Program Location

Enter Amount for Additional Time

This location determines the amount needed to add more time to a dry cycle. The amount for additional time is programmable from a minimum of 0.05 to a maximum of 25.00 adjustable in 0.01 increments.

PL13-Program Location

Enter Prepurge Time 0 to 25-seconds

When the Phase 7 controller detects the need for heat, it will wait for this prepurge time to expire before actually sending the signal for the heat to turn on.

Enter DSI Purge Time 0 to 25-seconds

After the controller sends the heat signal, the controller will wait for the direct spark ignition (DSI) purge time to expire before it checks to see if the gas valve return signal is present.

Enter DSI Proof Time 0 to 20-seconds

After the controller receives a gas valve signal within the DSI purge time, the controller will begin a DSI proof timer. After the DSI proof time has expired, the controller will recheck for the gas signal.

Enter Buzz Time 1 to 9 beeps

If the buzzer mode is set to “ON”, this location determines how many times the buzzer will beep at the end of an Anti-Wrinkle cycle.

Enter Pause Time 0 to 3 minutes

If the pause button is pressed and the main door is open, the controller will wait for the pause time defined in this setting to expire. Once the time has expired, the controller will begin to count down the dry time. If the pause button is not pressed prior to opening the door, the controller will not wait for the pause time before counting down the dry time.

PL14-Program Location

Enter Lint Cleaning Frequency 0 to 10 hours

This feature monitors the hours of drying time and compares it with the Lint Cleaning Frequency setting in PL14. Once the lint cleaning frequency time has been met, the controller will begin prompting the user to clean the lint drawer. The controller will allow two (2) more hours of drying time before locking out the controller. The controller will not respond until after the lint drawer has been cleaned out. When the lint drawer is opened, the display will read “LINT ACCESS OPEN,” and when the lint drawer is closed, the controller will go back to a ready state and will read “Ready, Insert 25¢ to Start” (NOTE: The lint access **must be** opened for 5-seconds or more for the reset to occur).

Enter Retry Count 0 to 2

This count is used to determine how many ignition attempts are allowed if an ignition attempt is unsuccessful. This counter increments when the heat output engages and the valve signal is lost after the trial for ignition period expires. This counter also will automatically reset once an ignition attempt is successful. The retry count range is from 0 to 2.

Anti-Wrinkle

This program keeps items wrinkle-free when they are not removed from the dryer promptly at the end of the drying cycle and/or cooling cycle.

When the drying and cooling cycles are completed, the dryer will shut off, the tone will sound, and the liquid crystal display (L.C.D.) will read "CYCLE DONE." If the door is not opened, the Phase 7 Coin microprocessor controller (computer) will wait an initial 15 minute delay time. Once the initial 15 minute delay time has expired, the fan will start and the basket (tumbler) will rotate (without heat) for an On time of 15 seconds. When the fan and basket start the display will read "ANTI-WRINKLE". Immediately following the 15 second On time the control will go into a 5 minute OFF time at which point it will display "CYCLE DONE." The Phase 7 Coin microprocessor controller (computer) will repeat this process of 15 seconds "ON" and 5 minutes "OFF" until either the doors are opened or 99 minutes has elapsed, which ever comes first. Prior to each ON time, there is a 3-beep warning that the fan and basket (tumbler) rotation are about to start. The beeps at the end of the Anti-Wrinkle Cycle can be programmed to be ON/OFF refer to **page 10** for **PL01- SELECT BUZZER MODE**.

NOTE: The following information description is an explanation of the sensor activated fire extinguishing (S.A.F.E.) system functionality. This feature is programmed at the factory and effects dryers that are equipped with the S.A.F.E. system.

Sensor Activated Fire Extinguishing (S.A.F.E.) System

While the dryer is in an idle state or 20-seconds after the heat turns off, the Phase 7 controller monitors the S.A.F.E. temperature probe located in the top of the basket (tumbler) chamber and records the minimum temperature. If the minimum recorded S.A.F.E. probe temperature is greater than 120° F (48° C) and the controller detects a 50° rise in temperature, this will be the trip point, and the S.A.F.E. routine will activate.

While a drying cycle is in process and the heat has turned on at least once, the Phase 7 controller monitors the exhaust temperature transducer. If the drying cycle temperature set point is set greater than 160° F (71° C) and the controller detects an exhaust temperature rise 25° F greater than set point, this will be the trip point, and the S.A.F.E. routine will activate. If set point is below 160° F (71° C) the trip point will be 185° F (85° C).

Once the S.A.F.E. routine is activated, the display will read "S.A.F.E. System Activated," and water will be injected into the basket (tumbler) chamber. Anytime water is being injected into the basket (tumbler), the basket (tumbler) drive will turn the load for 1-second every 15-seconds. This process will continue for a minimum of 2 minutes. After 2 minutes has elapsed, the controller will check if the temperature remained above trip point; if so, water will remain on. The controller will continue to check if temperature is above trip point every 30-seconds. If the water has been on for a constant 10 minutes, the water will be turned off regardless of the temperature, and the display will read "S.A.F.E. System Was Activated." If the temperature has dropped below trip point, the controller will turn off the water prior to 10 minutes.

SECTION VI

PROGRAMMING INSTRUCTIONS

A. INTRODUCTION TO PROGRAMMING

The various program selections are stored in the Phase 7 coin microprocessor controller (computer) and are broken down into fifteen (15) program locations. PL01 through PL14 are for dryer parameters and PL15 is reserved for factory settings.



ALL program changes are done through the keyboard (touch pad) selection keys on the front of the control panel.

ENTERING THE PROGRAMMING MODE:

First, make sure that no cycle is in progress and that the liquid crystal display (L.C.D.) reads “Ready, Insert 25¢ to Start,” then place the program switch in the “UP” position. This will put you into the programming mode.

EXITING THE PROGRAMMING MODE:

To exit the program mode, place the program switch in the “DOWN” position.

To alter the programming parameters, the operator will locate the parameter (program) that is to be changed. If the change is a numerical change (i.e., time and/or temperature), the operator will use the “HI” and “LO” keys to scroll through the numerical range of numbers, using “HI” to increase and “LO” to decrease. If an error is made, press the “PAUSE”  key ONCE, and the incorrect entry that was made will be cancelled. Once the entry is made and the parameter (program) set does not need to be changed, press the “PP”  key, and the Phase 7 coin microprocessor controller (computer) will save the change and will advance to the next parameter.

If the parameter (program) change is a feature change, such as changing the temperature conversion from degree Fahrenheit (°F) to degree Celsius (°C), the operator will press the “HI” or “LO” key. This will toggle between choices. Once the entry is made, or if the parameter (program) does not need to be changed, press the “PP”  key and the Phase 7 coin microprocessor controller (computer) will save the change and will advance to the next program selection.

The Phase 7 coin microprocessor controller (computer) allows the operator to scroll through the various programming locations and select the parameter to be changed. If no other programs (parameters) need to be changed, the user can get out of the program mode by toggling the program switch to the “DOWN” position. The Phase 7 coin microprocessor controller (computer) will be returned to the operating mode, and the liquid crystal display (L.C.D.) will read “Ready, Insert 25¢ to Start” in coin mode or “Select Temperature” in free mode.

B. PROGRAM LOCATION SUMMARY

Phase 7 Coin Program Location Summary	
PL01	Select Language Select Currency Select Model Select Temp Scale Select Buzzer Mode Select Dry Mode Select Vending Safe Guard Select Vending Mode Select Rotation Sensor Mode
PL02	High Dry Temperature
PL03	High Cool Temperature High Cool Time
PL04	Low Dry Temperature
PL05	Low Cool Temperature Low Cool Time
PL06	Permanent Press Temperature
PL07	Permanent Press Cool Temperature Permanent Press Cool Time
PL08	Left Coin Denomination
PL09	Right Coin Denomination
PL10	Time For Amount to Start
PL11	Amount to Start
PL12	Amount For Additional Time
PL13	Enter Pre-Purge Time Enter DSI Purge Time Enter DSI Proof Time Buzz Time Pause Time
PL14	Lint Cleaning Frequency Retry Count
PL15	Hidden Locations

P/N: 114548



C. PROGRAMMING FLOWCHARTS

The following section of this manual explains the programming of the Phase 7 coin microprocessor controller (computer) program locations (system parameters) through the use of flowcharts. A flowchart is nothing more than a diagram of the programming process.

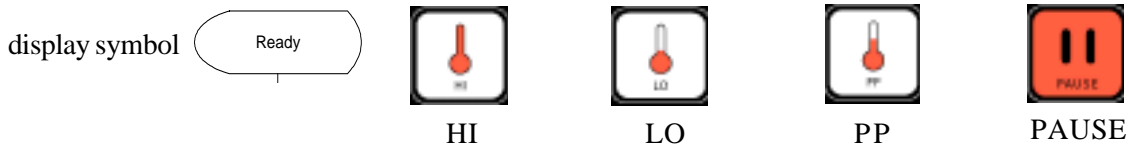
Five (5) different symbols will be used in these flowcharts:



Each display symbol will represent a readout on the Phase 7 coin microprocessor controller (computer) liquid crystal display (L.C.D.), and each key symbol will represent a key that is pressed. For example:

1. If the flowchart shows the symbol  the Phase 7 coin microprocessor controller (computer) L.C.D. display will read the same.
2. If the flowchart shows a key symbol, you will press that specific key on the keyboard (touch pad) label.
3. a. The flowchart arrows (i.e., ) represent the program path.
b. On the sides of these flowcharts are explanations of the flowchart procedure, and in some cases the programming limits or options.

Listed on the next page is an index of the flowcharts to follow.

Flowchart Table of Contents

Programming Location	Title	Page
PL #01	Selecting Display Language	22
PL #01	Selecting Currency	23
PL #01	Selecting Model Type	24
PL #01	Selecting Temp Scale	25
PL #01	Selecting Buzzer Mode	26
PL #01	Selecting Dry Mode	27
PL #01	Selecting Vending Safeguard	28
PL #01	Selecting Vending Mode	29
PL #01	Selecting Rotation Sensor Mode	30
PL #02	Setting High Cycle Dry Temp	31
PL #03	Setting High Cycle Cool Temp	32
PL #03	Setting High Cycle Cool Time	33
PL #04	Setting Low Cycle Dry Temp	34
PL #05	Setting Low Cycle Cool Temp	35
PL #05	Setting Low Cycle Cool Time	36
PL #06	Setting Permanent Press Cycle Dry Temp	37
PL #07	Setting Permanent Press Cycle Cool Temp ..	38
PL #07	Setting Permanent Press Cycle Cool Time	39
PL #08	Setting Left Coin Denomination	40
PL #09	Setting Right Coin Denomination	41
PL #10	Setting Time for Amount to Start	42
PL #11	Setting Amount to Start	43
PL #12	Setting Amount for Additional Time	44
PL #13	Setting Prepurge Time	45
PL #13	Setting DSI Purge Time	46
PL #13	Setting DSI Proof Time	47
PL #13	Setting Buzz Time	48
PL #13	Setting Pause Time	49
PL #14	Setting Lint Cleaning Frequency	50
PL #14	Setting Retry Count	51
	Clearing Credit	52
	Accessing and Clearing Coin Vault Total	53

Selecting Display Language

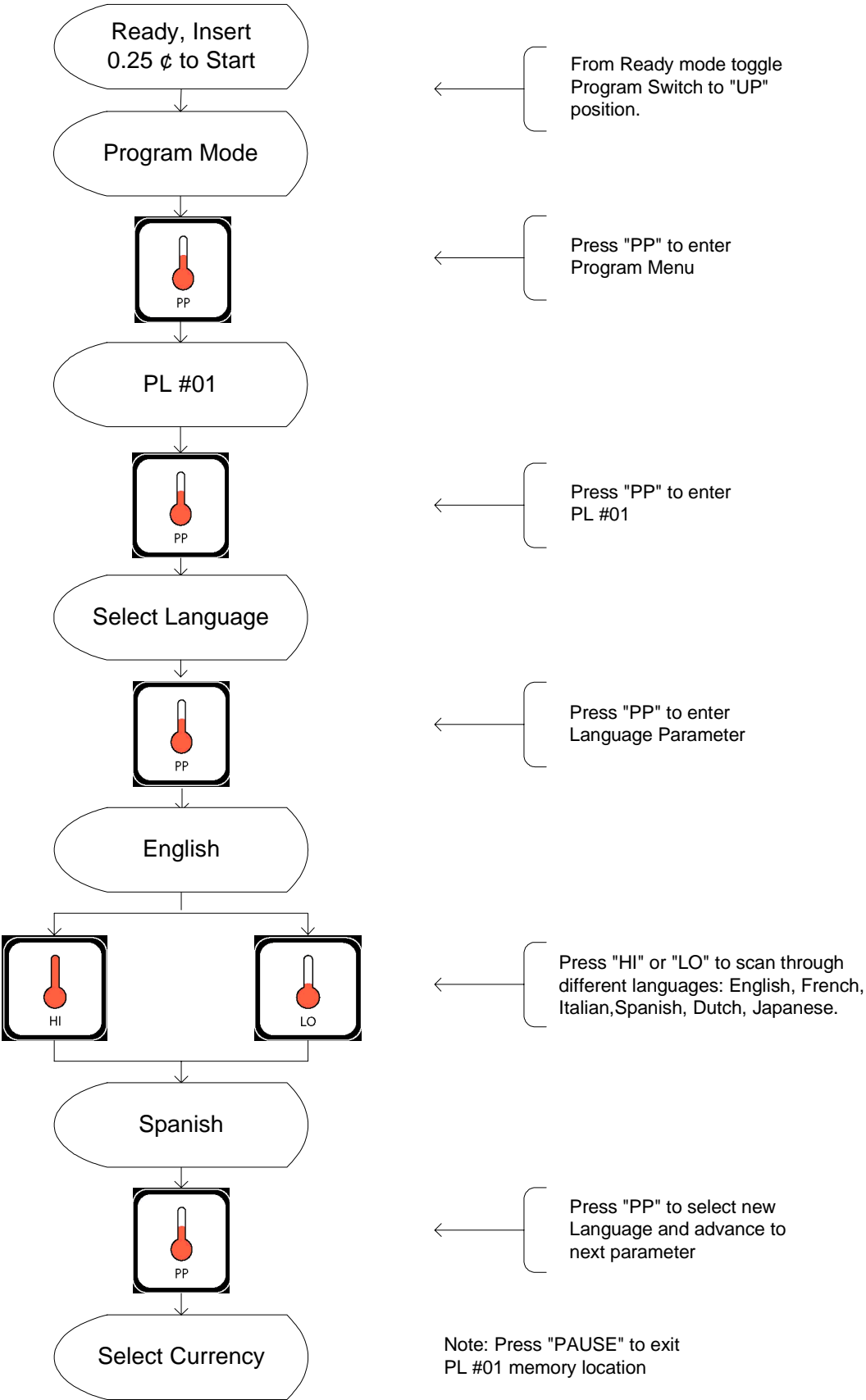

Selecting Currency

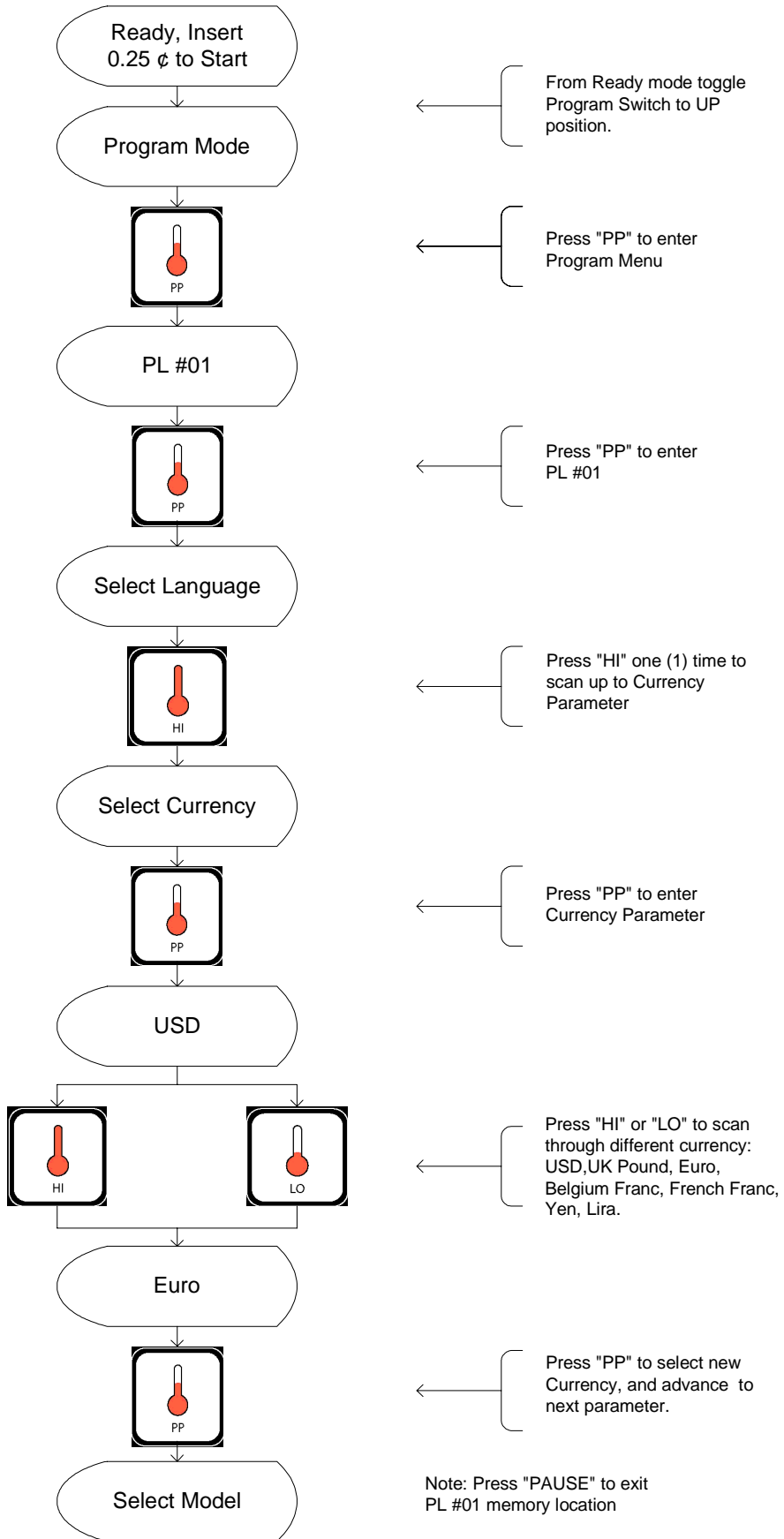

Selecting Model Type

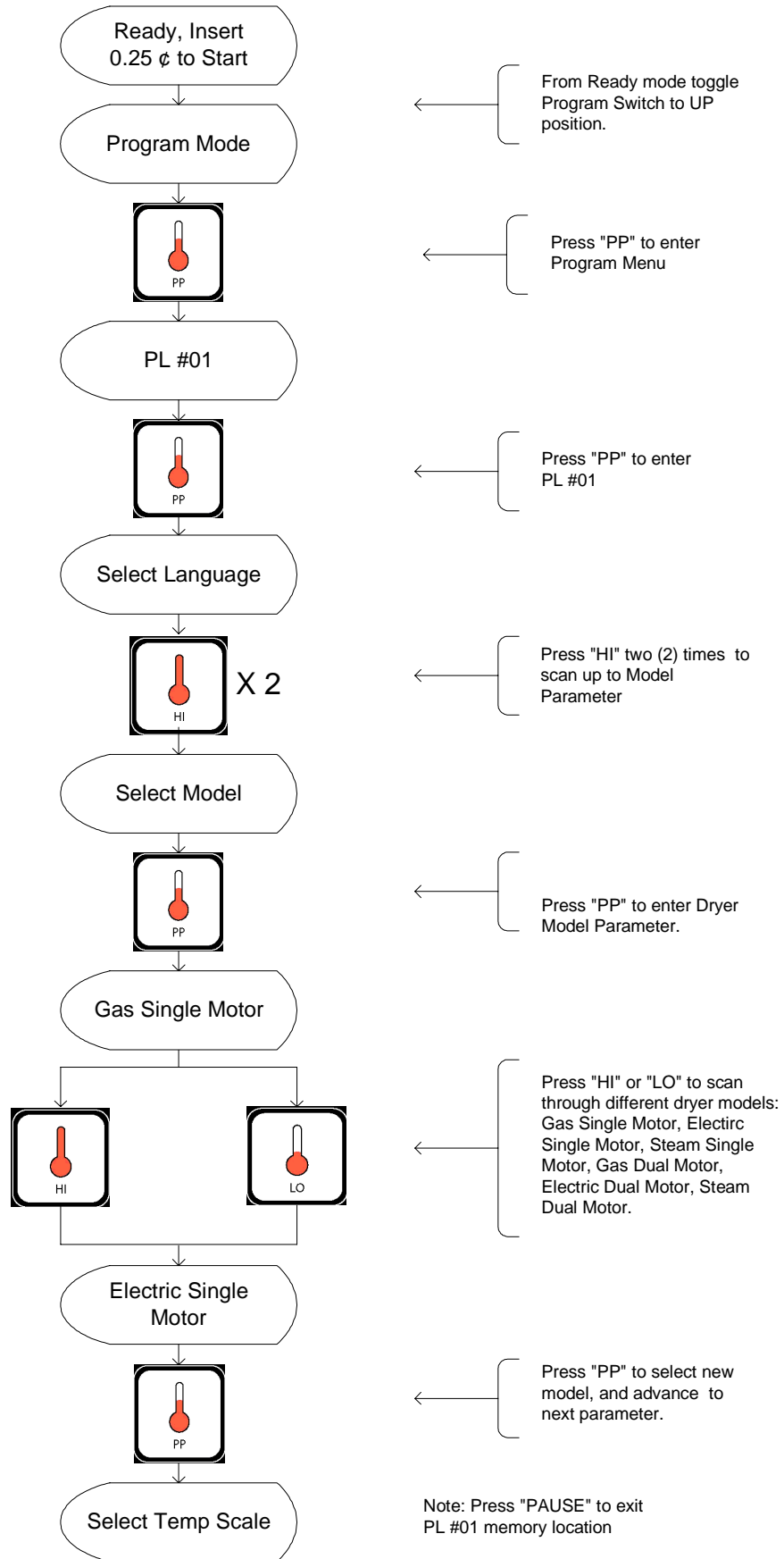

Selecting Temp Scale

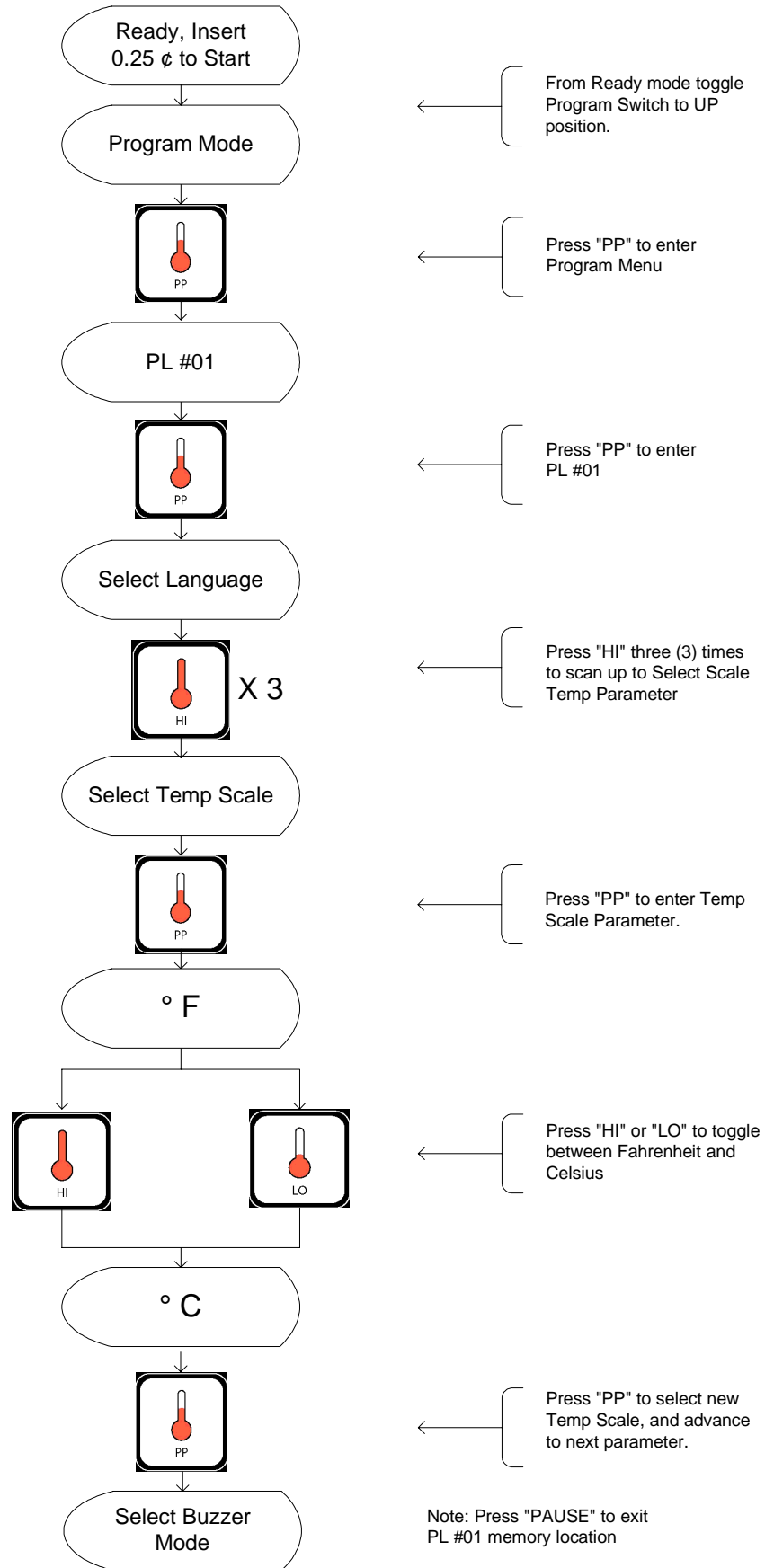

Selecting Buzzer Mode

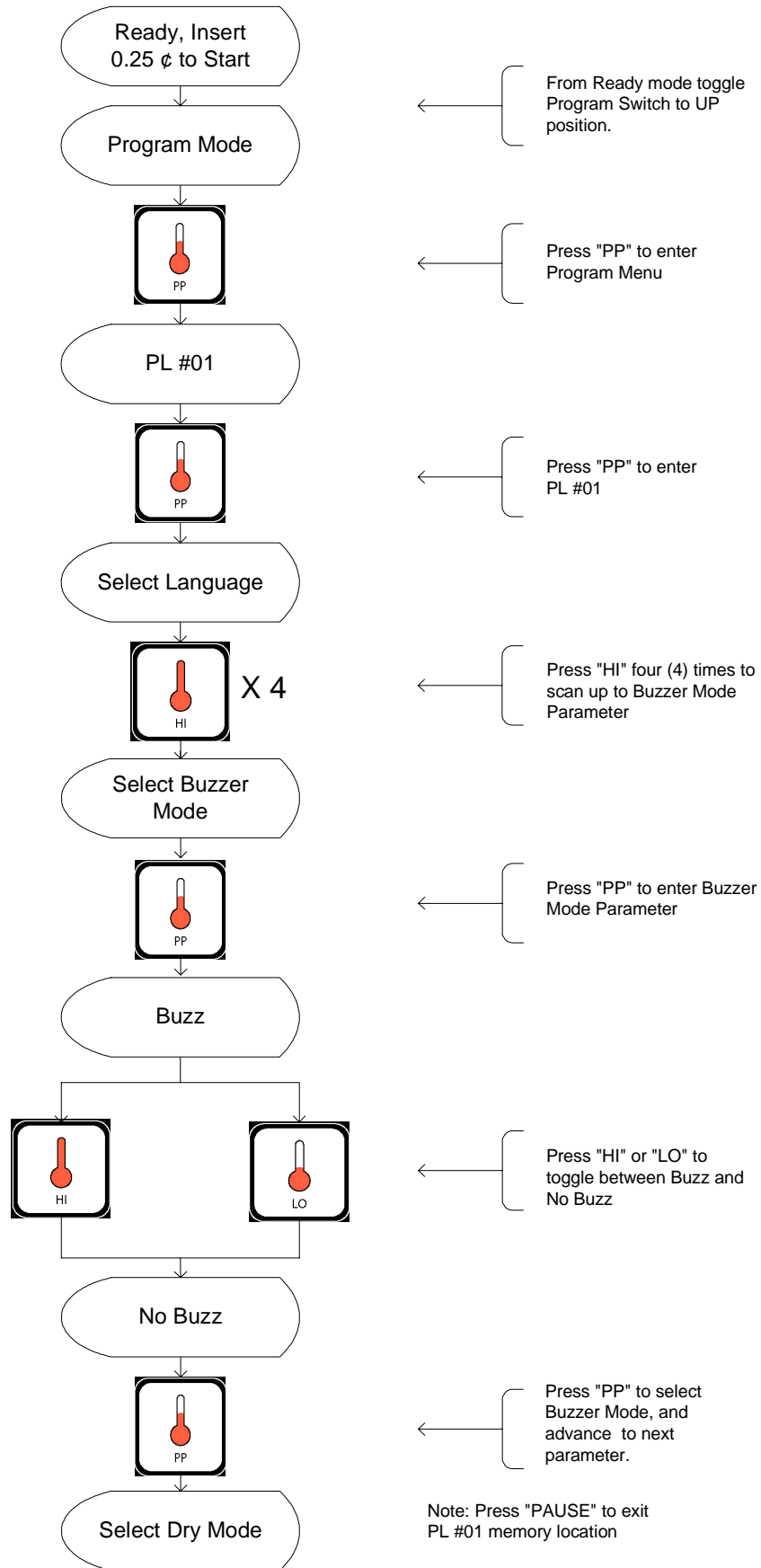

Selecting Dry Mode

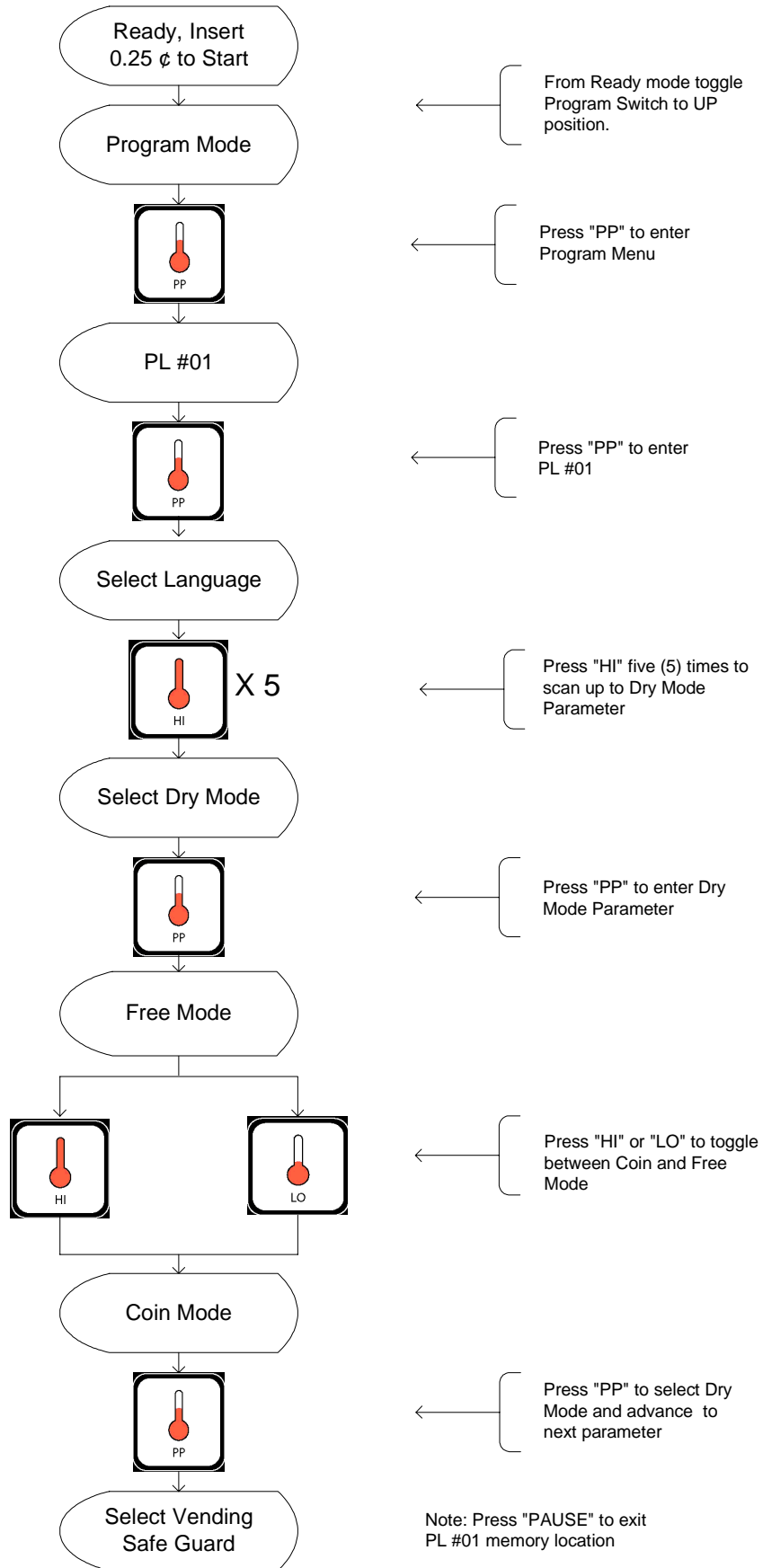

Selecting Vending Safe Guard

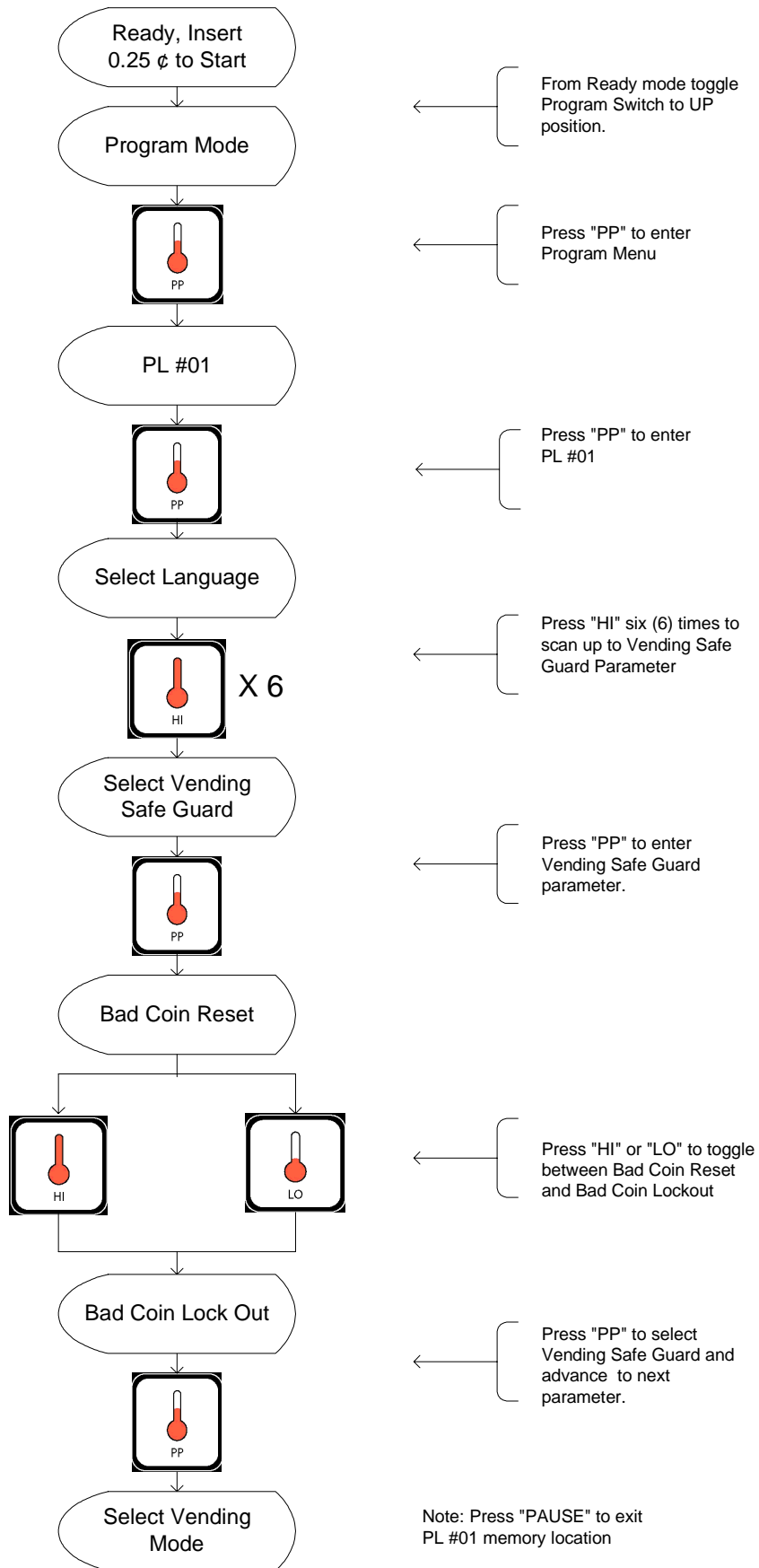

Selecting Vending Mode

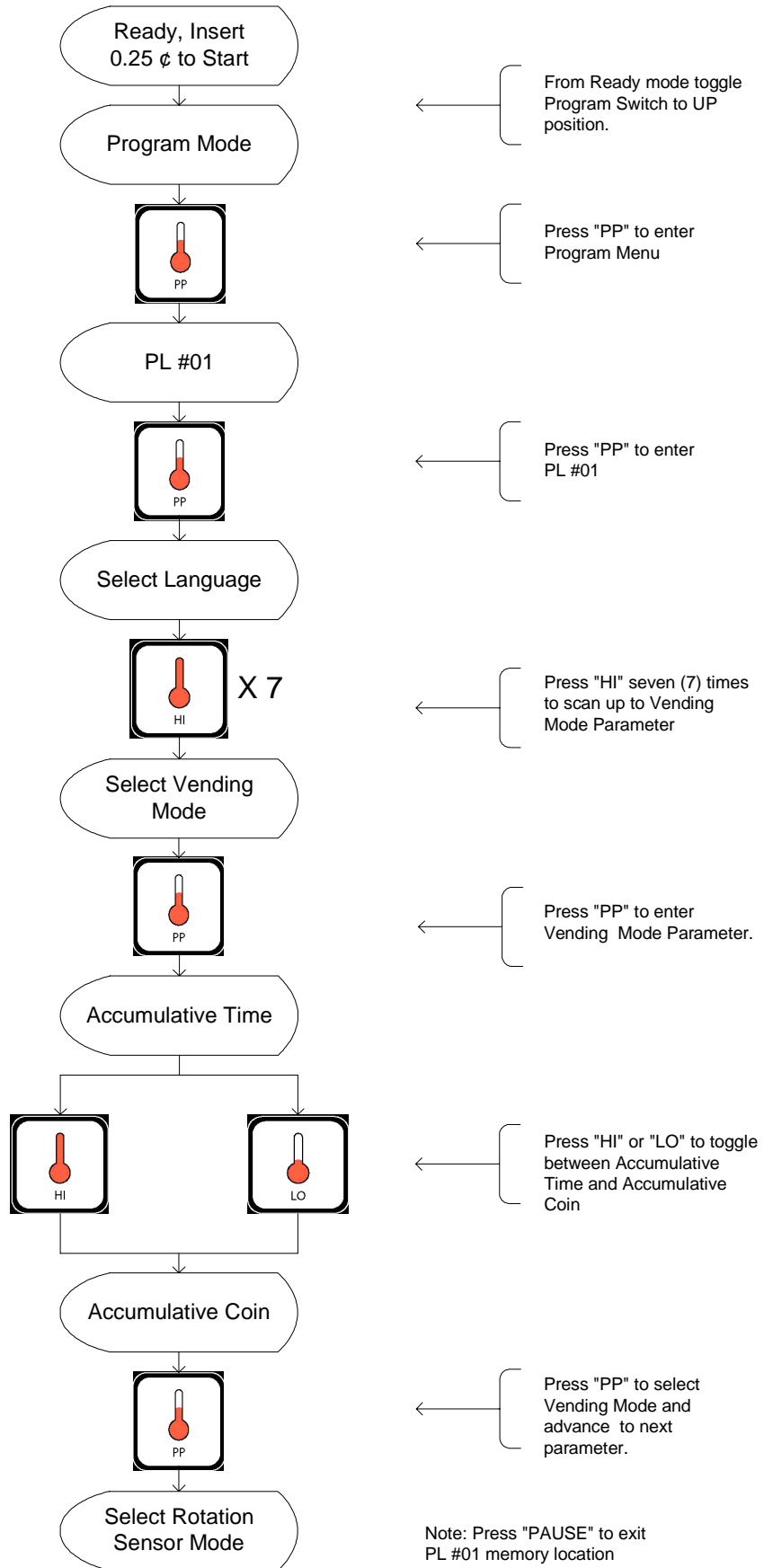

Selecting Rotation Sensor Mode

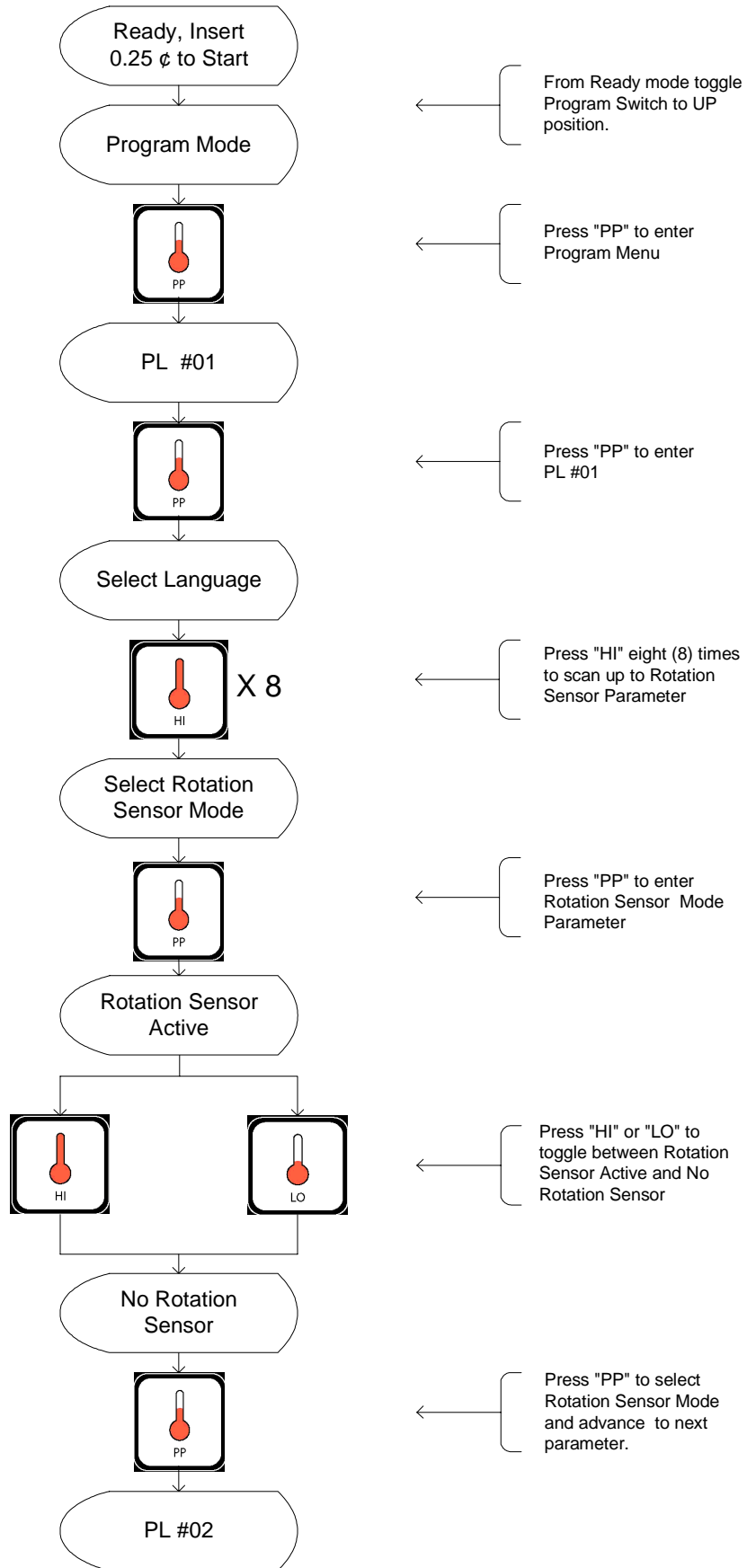

Setting High Cycle Dry Temp

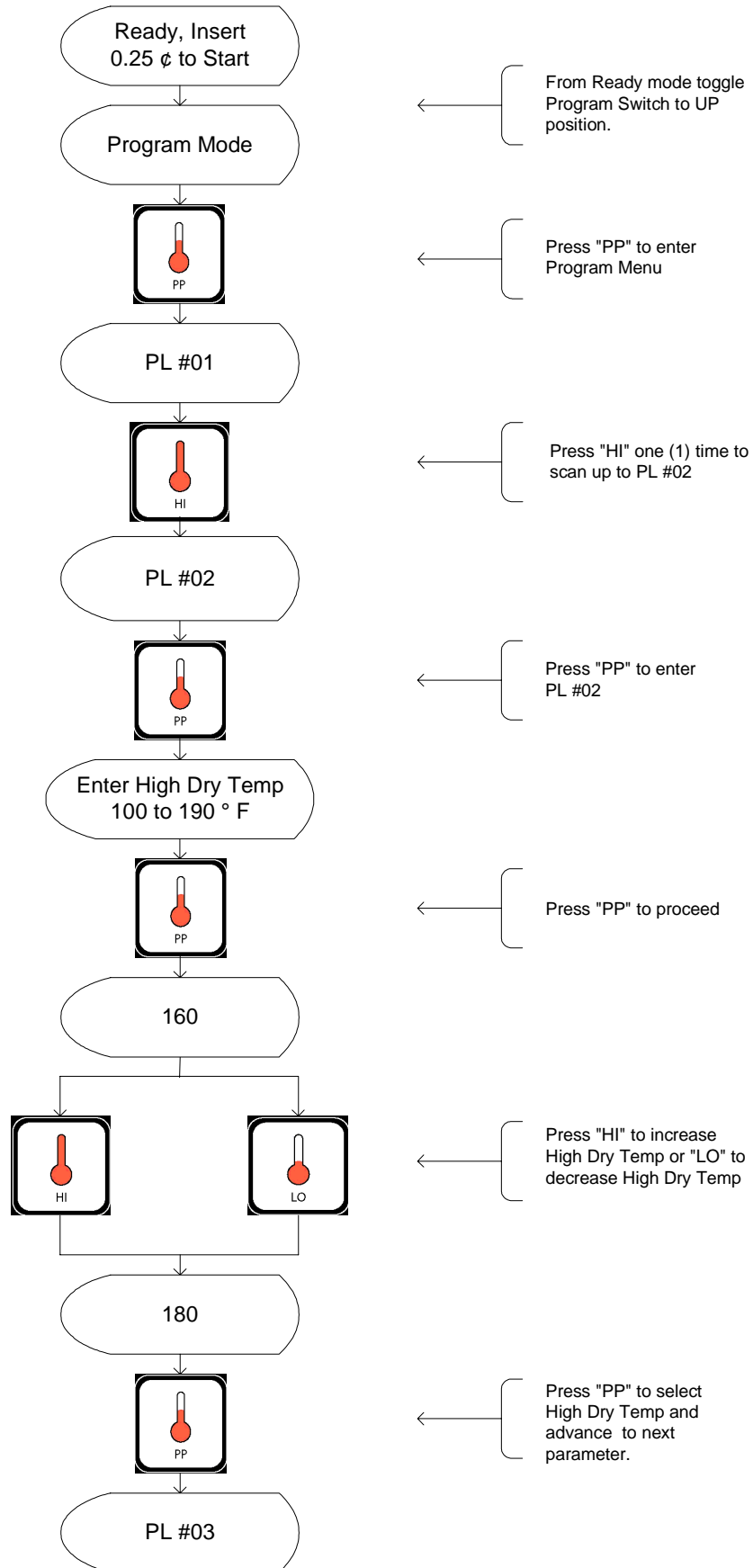

Setting High Cycle Cool Temp

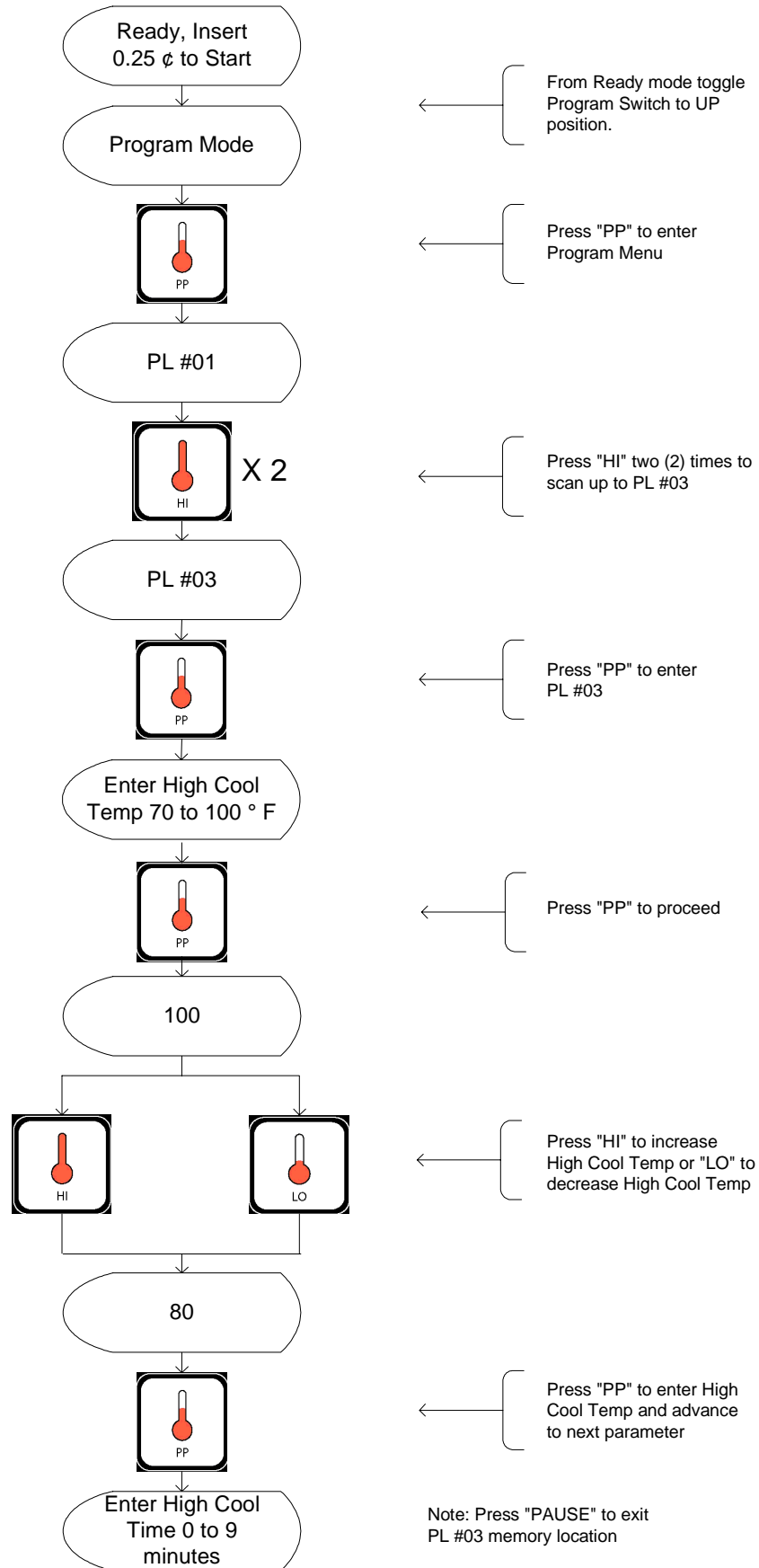

Setting High Cycle Cool Time

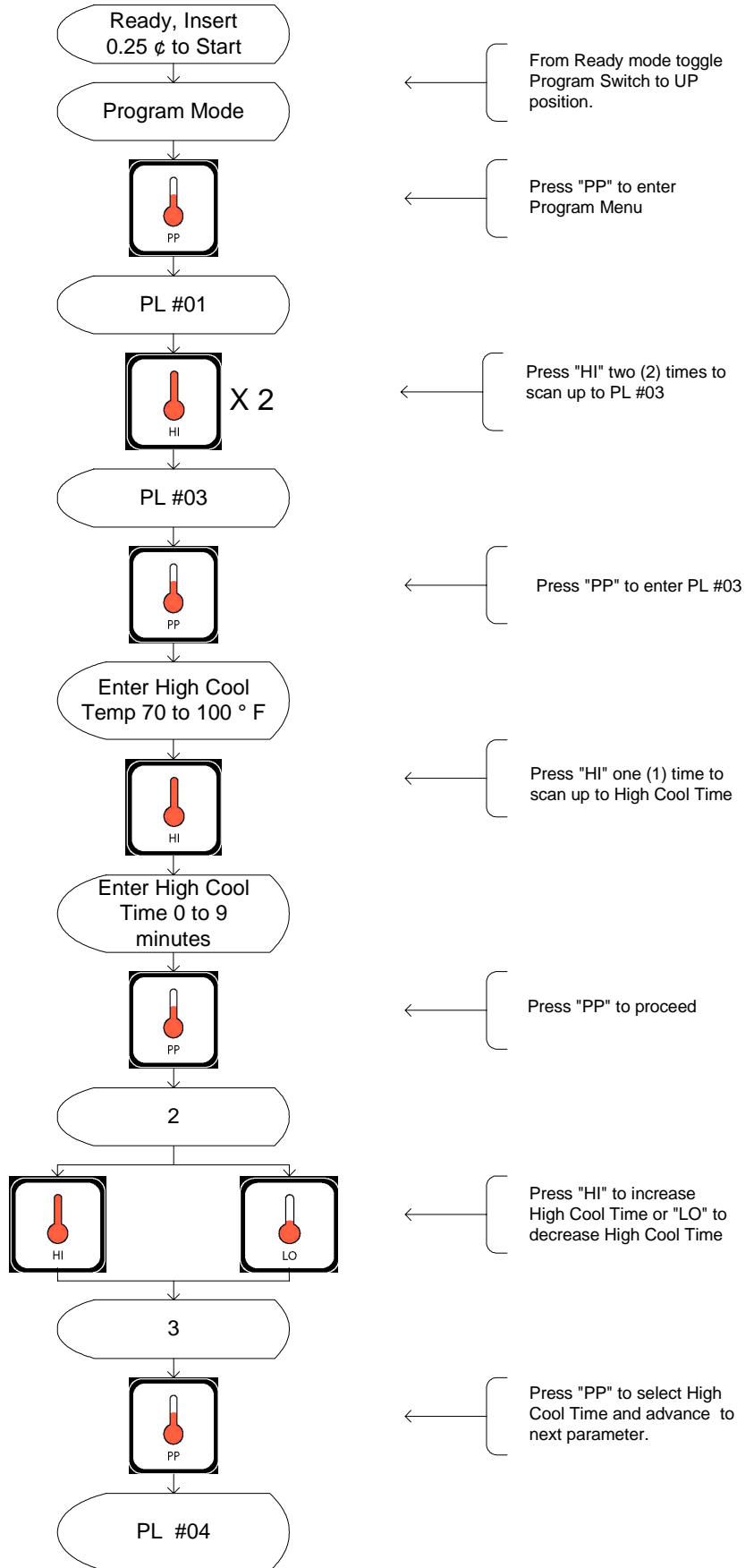

Setting Low Cycle Dry Temp

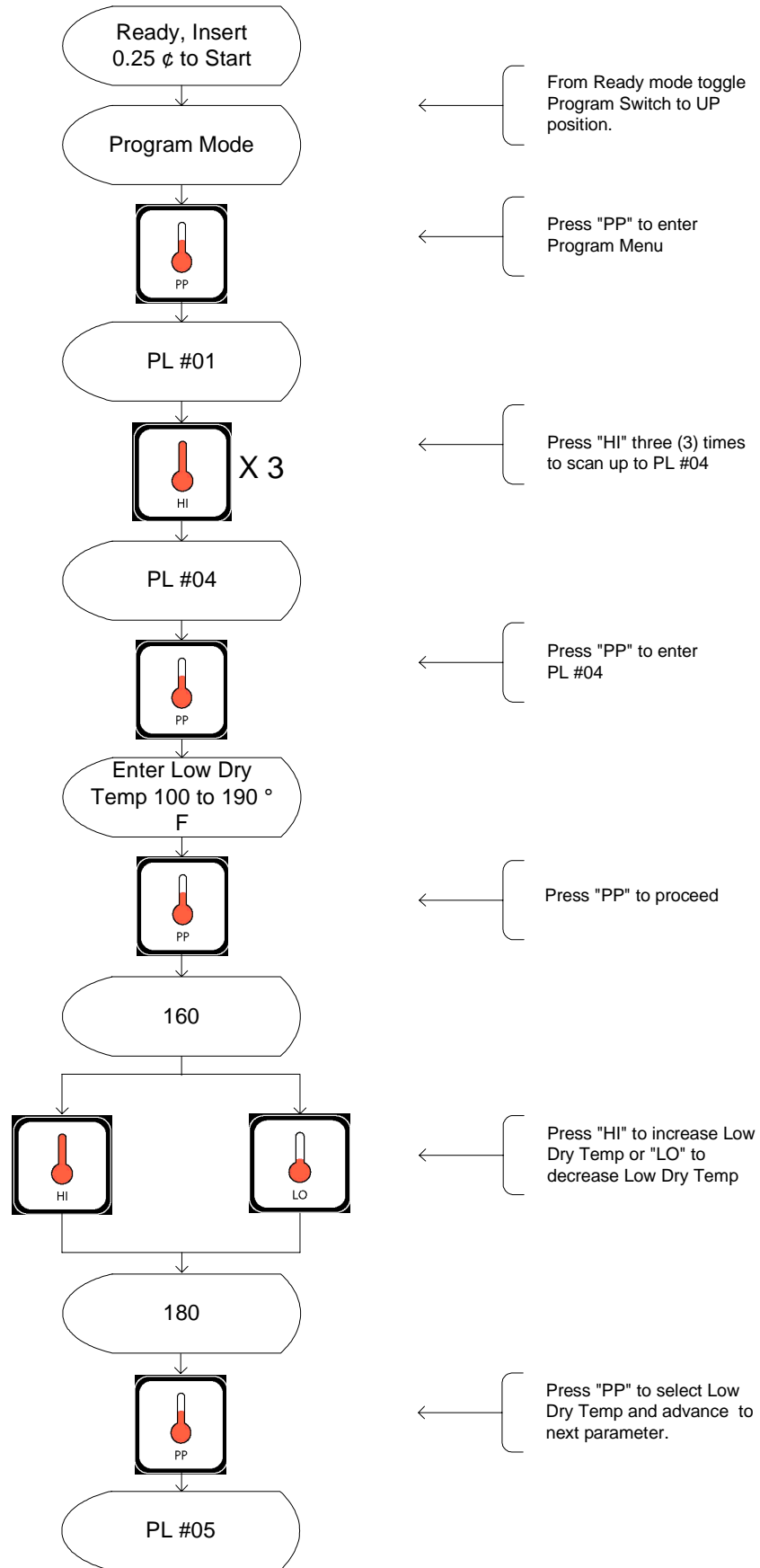

Setting Low Cycle Cool Temp

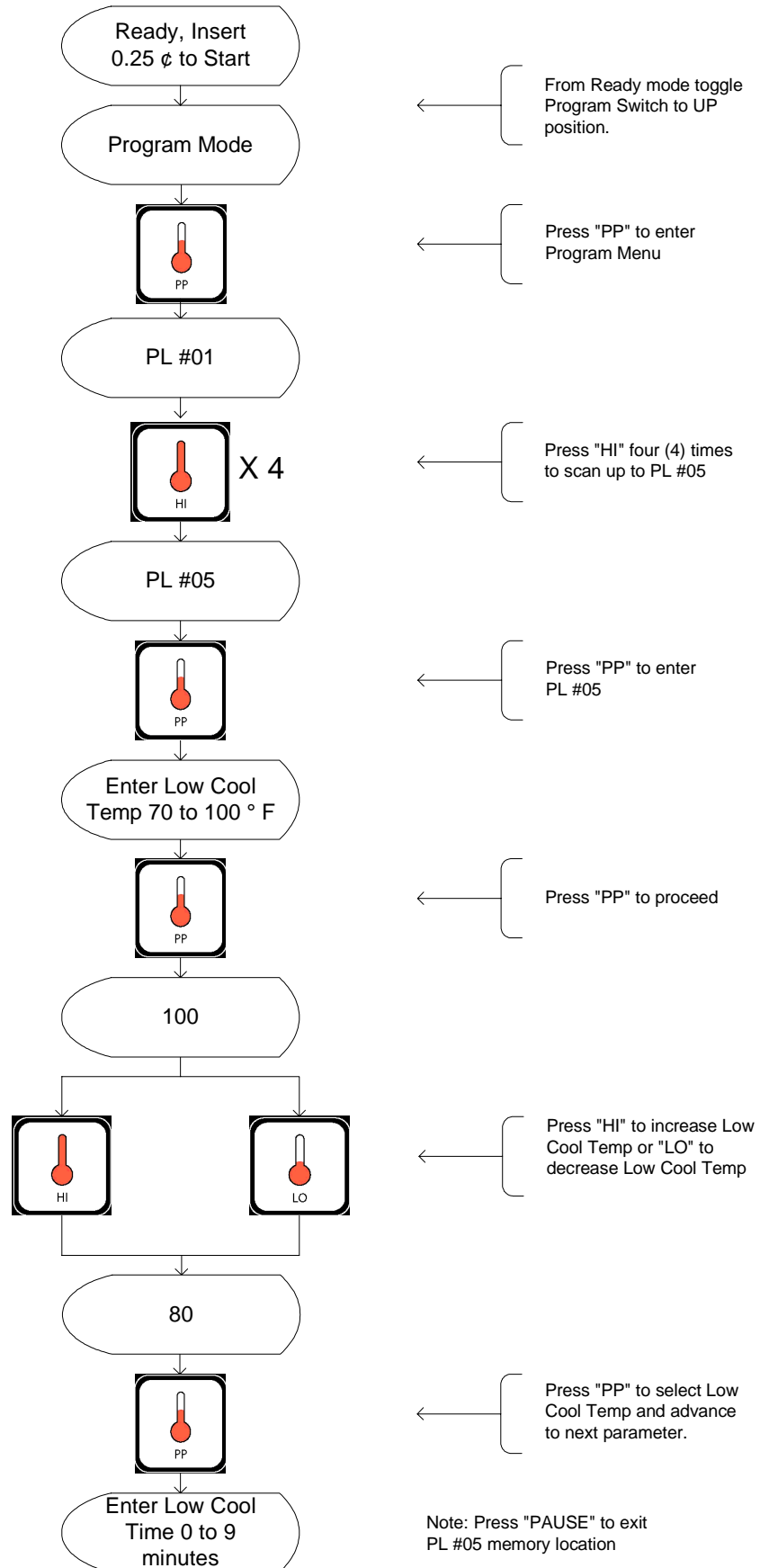

Setting Low Cycle Cool Time

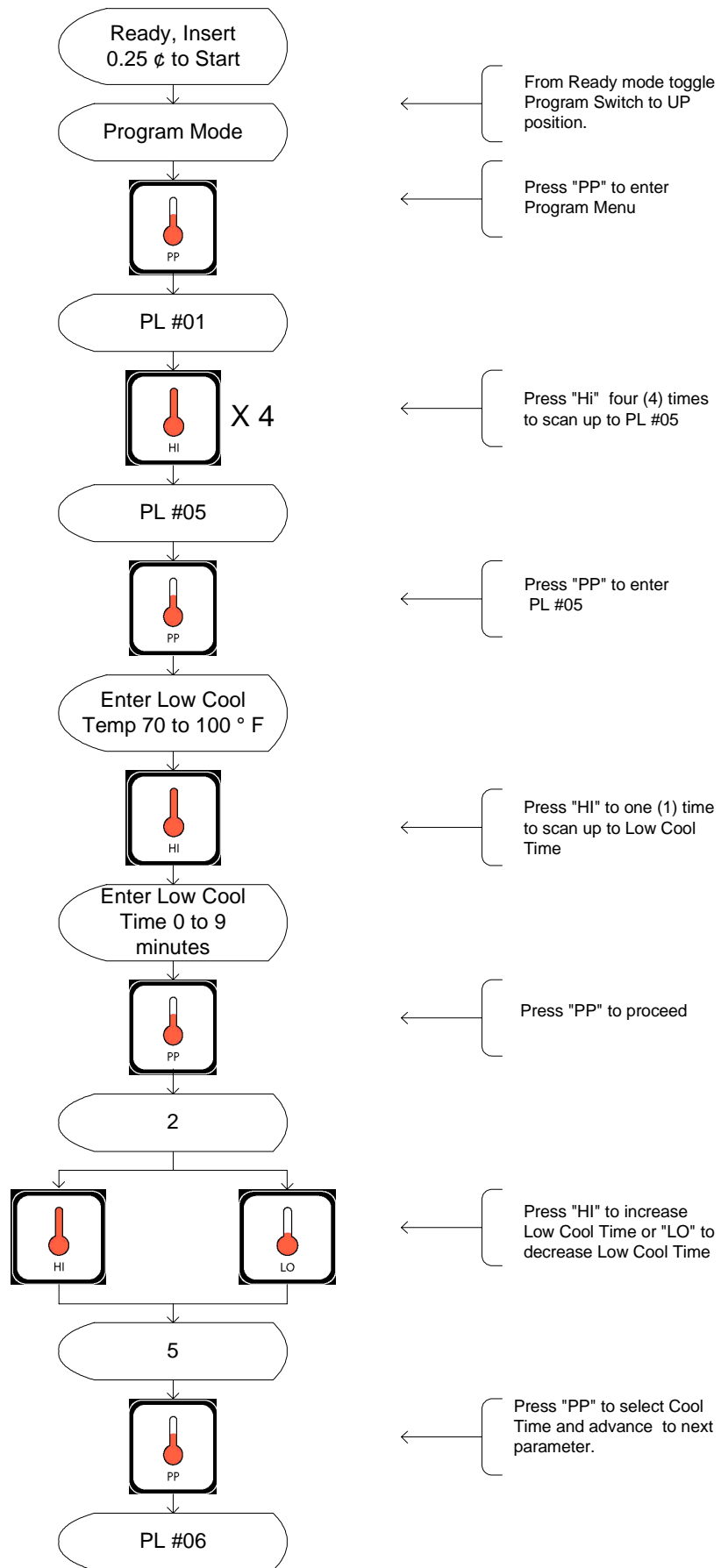

Setting Permanent Press Cycle Dry Temp

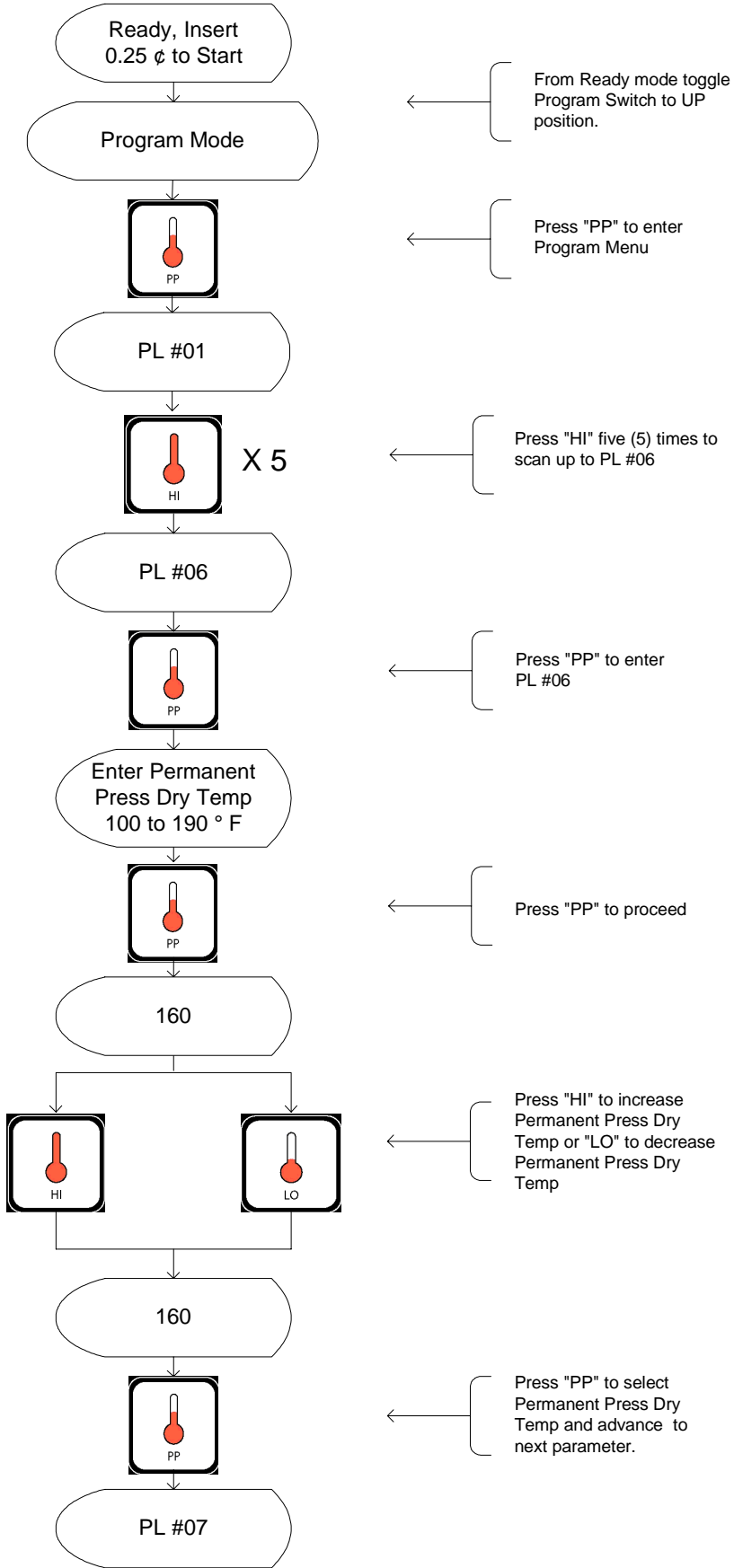

Setting Permanent Press Cycle Cool Temp

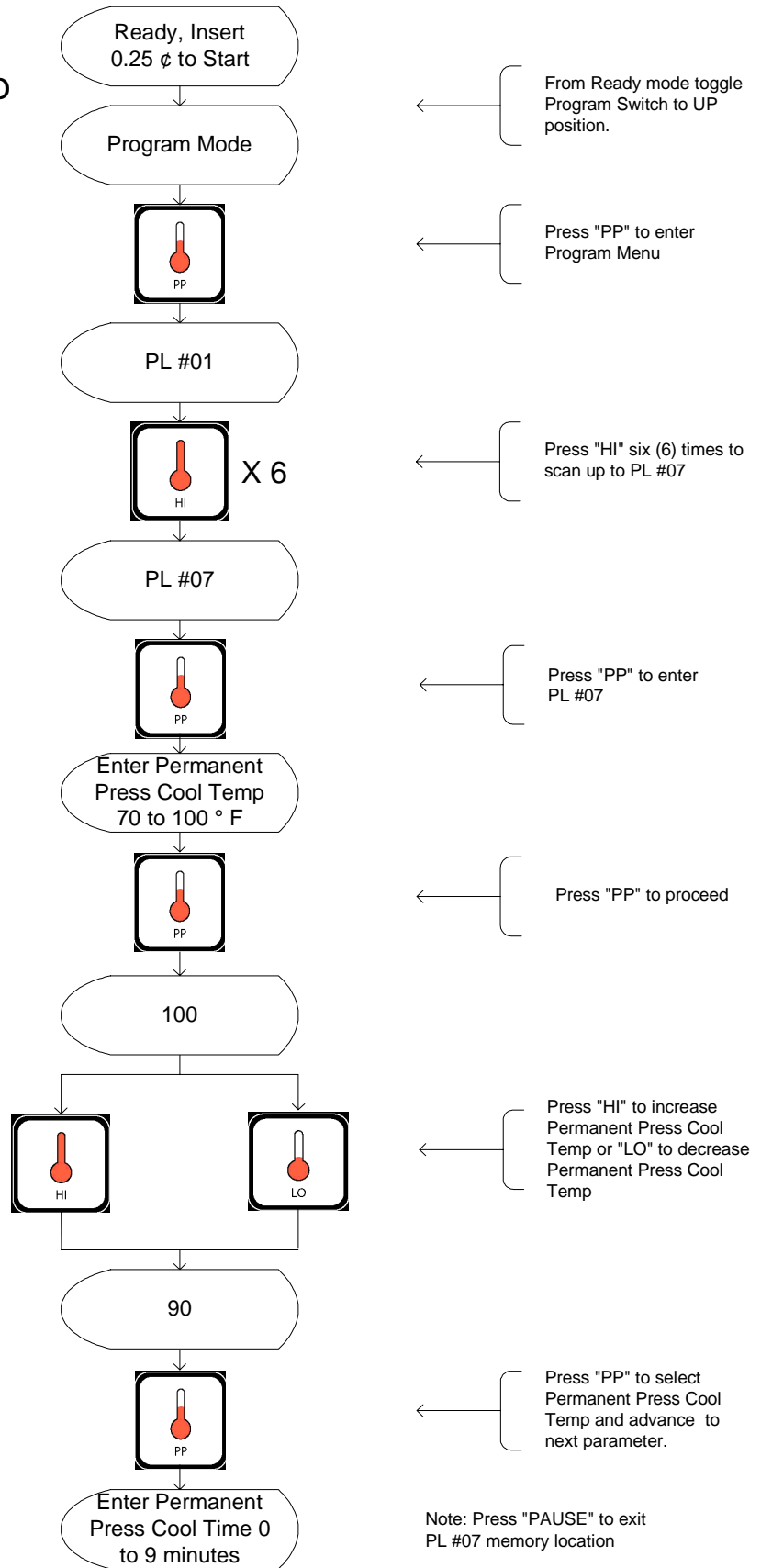

Setting Permanent Press Cycle Cool Time

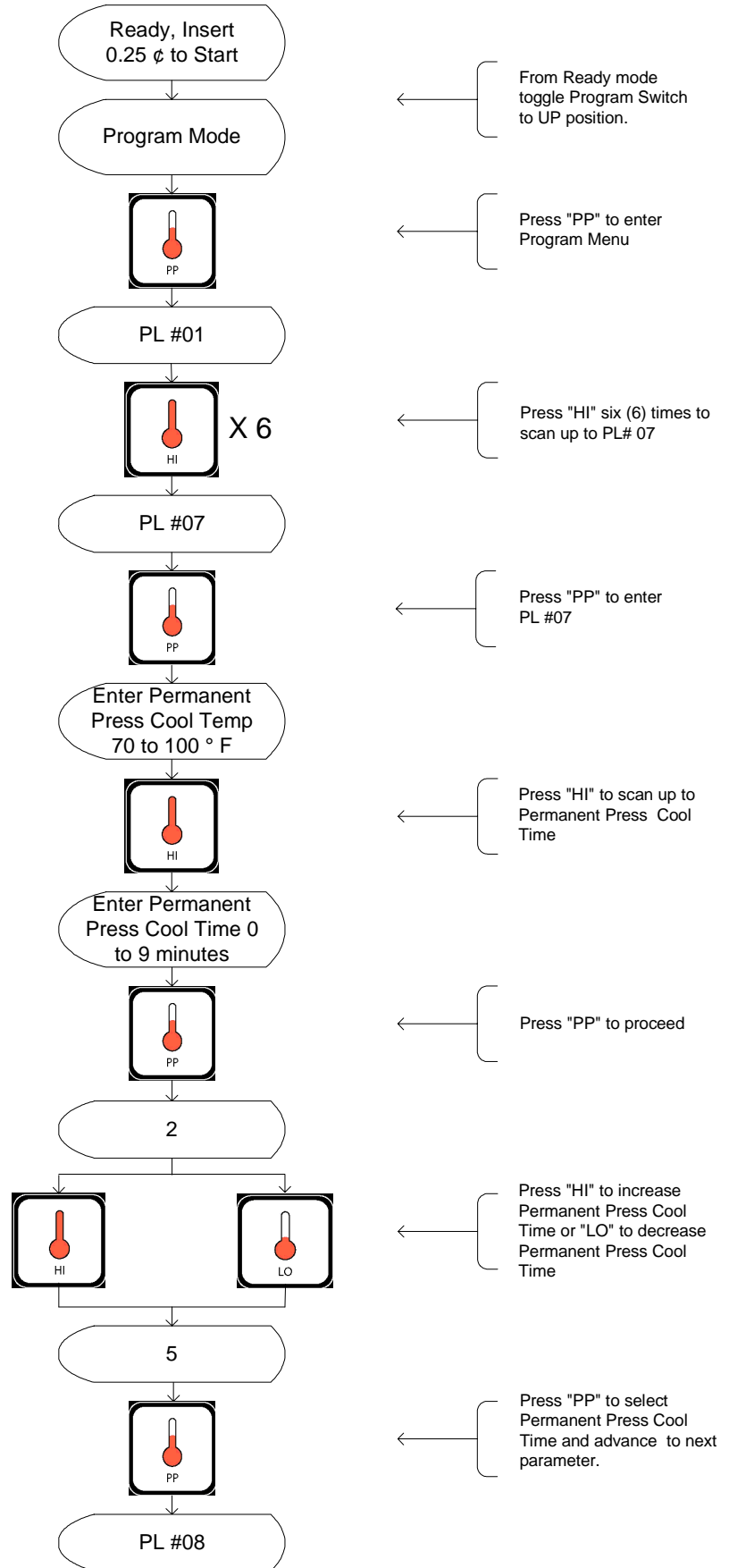

Setting Left Coin Denomination

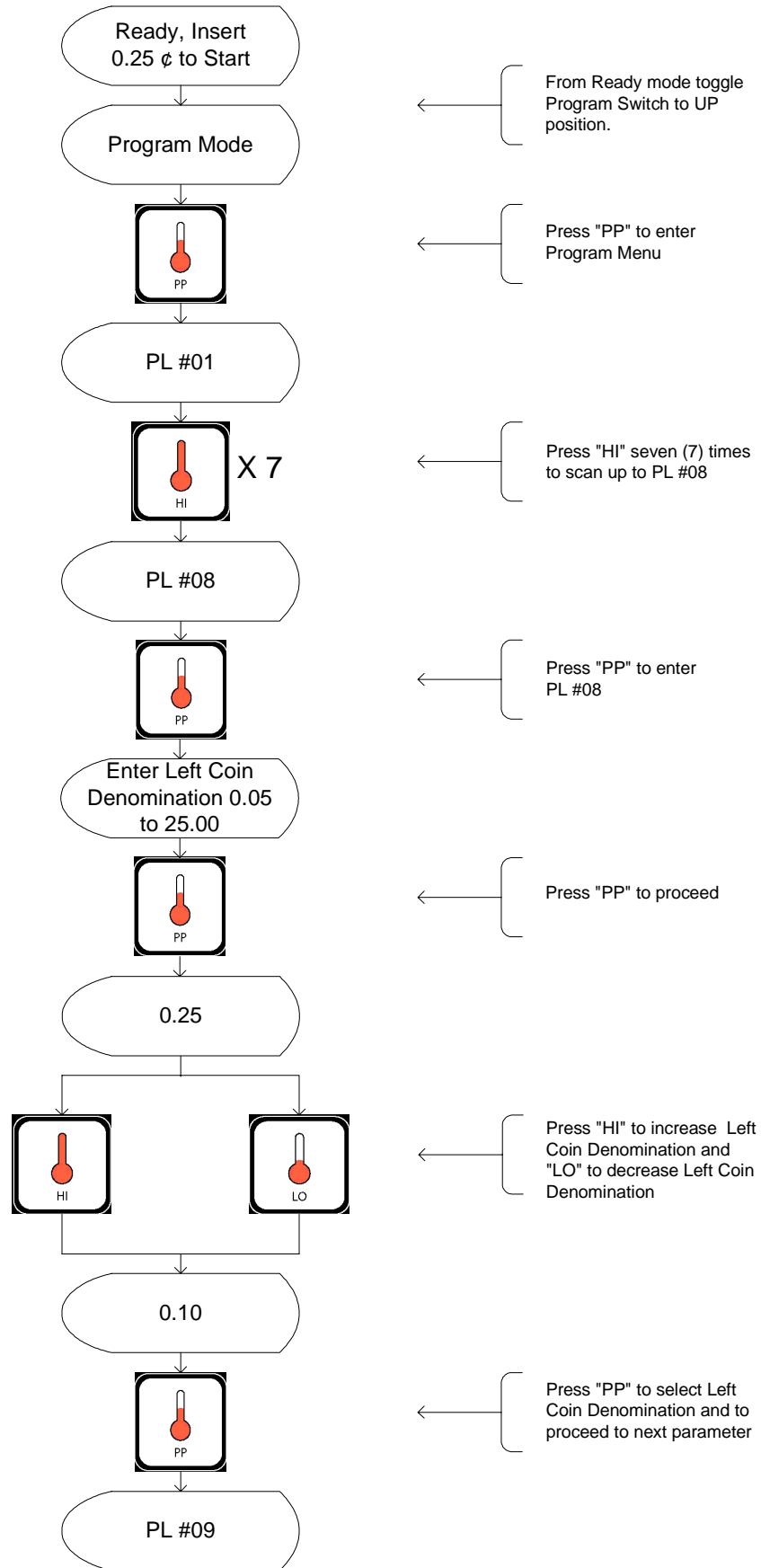

Setting Right Coin Denomination

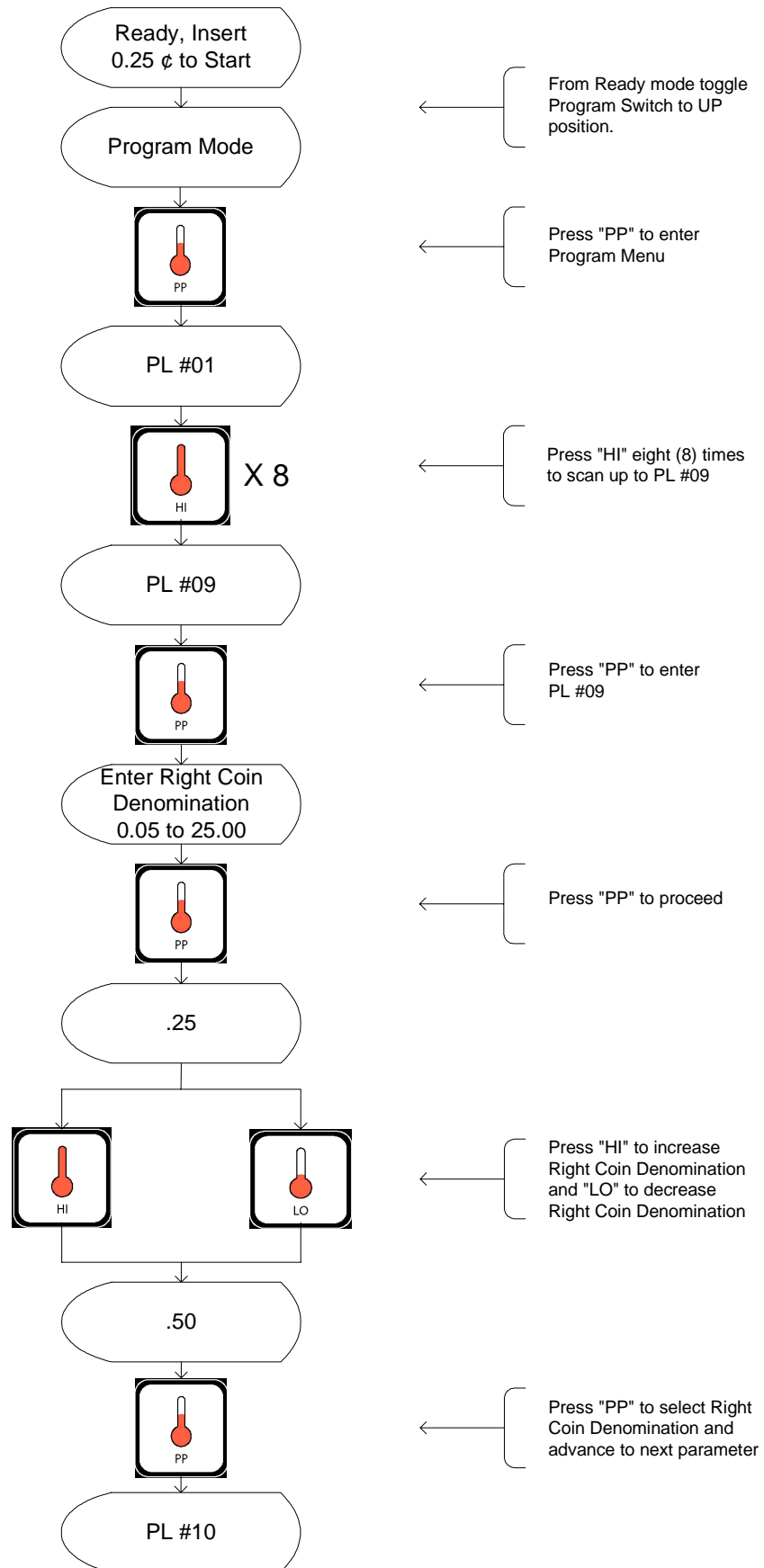

Setting Time for Amount to Start

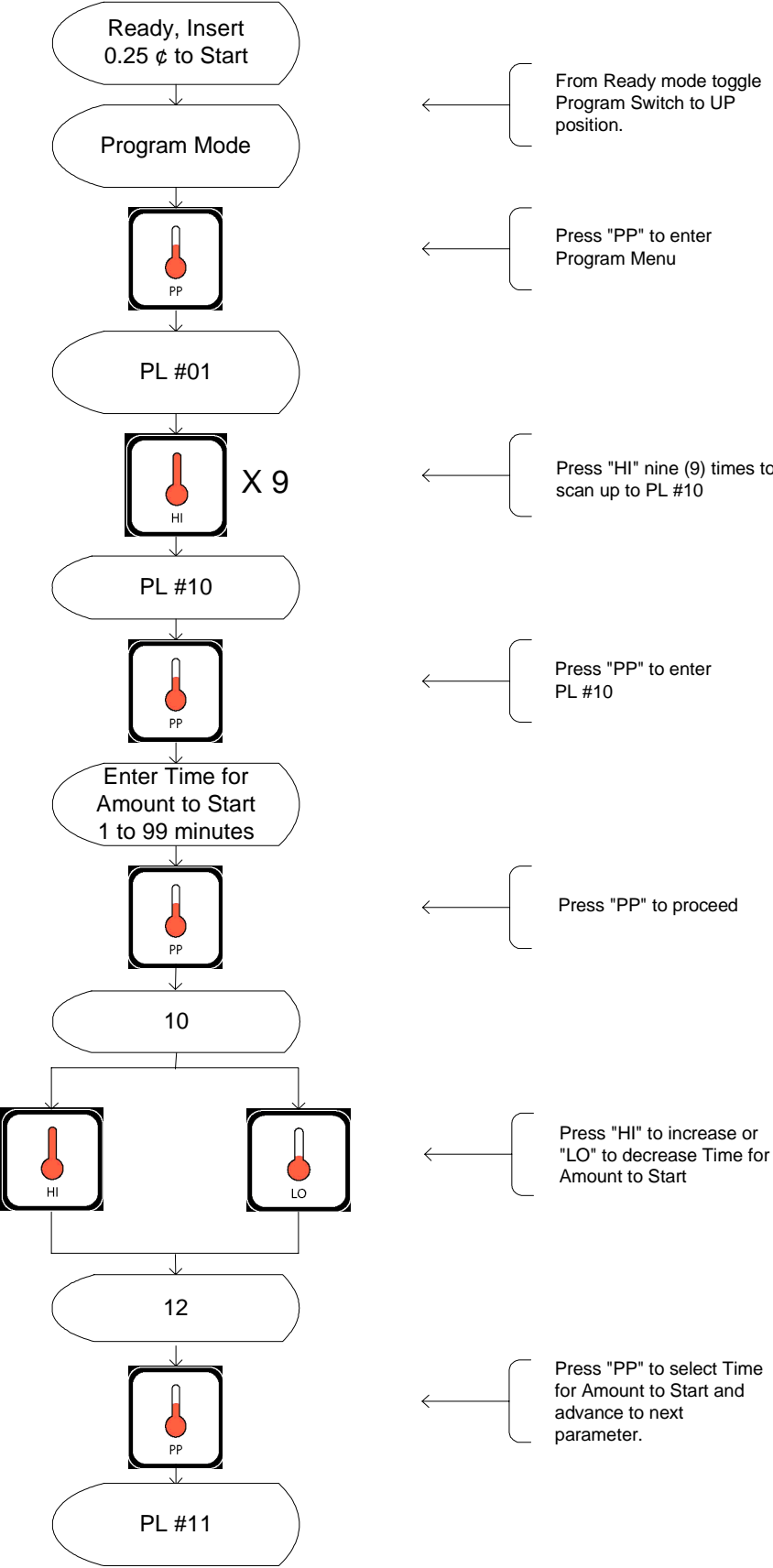

Setting Amount To Start

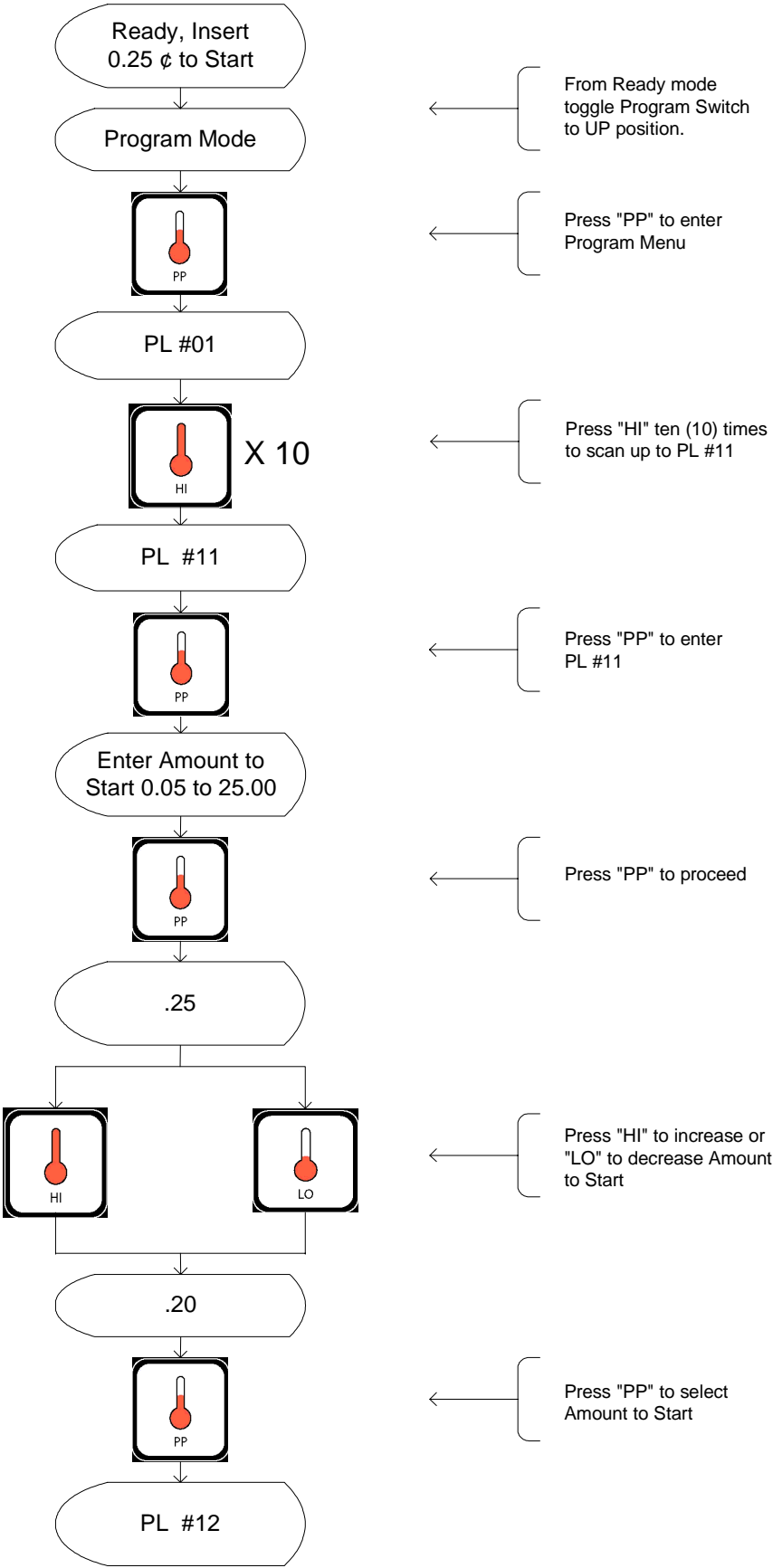

Setting Amount for Additional Time

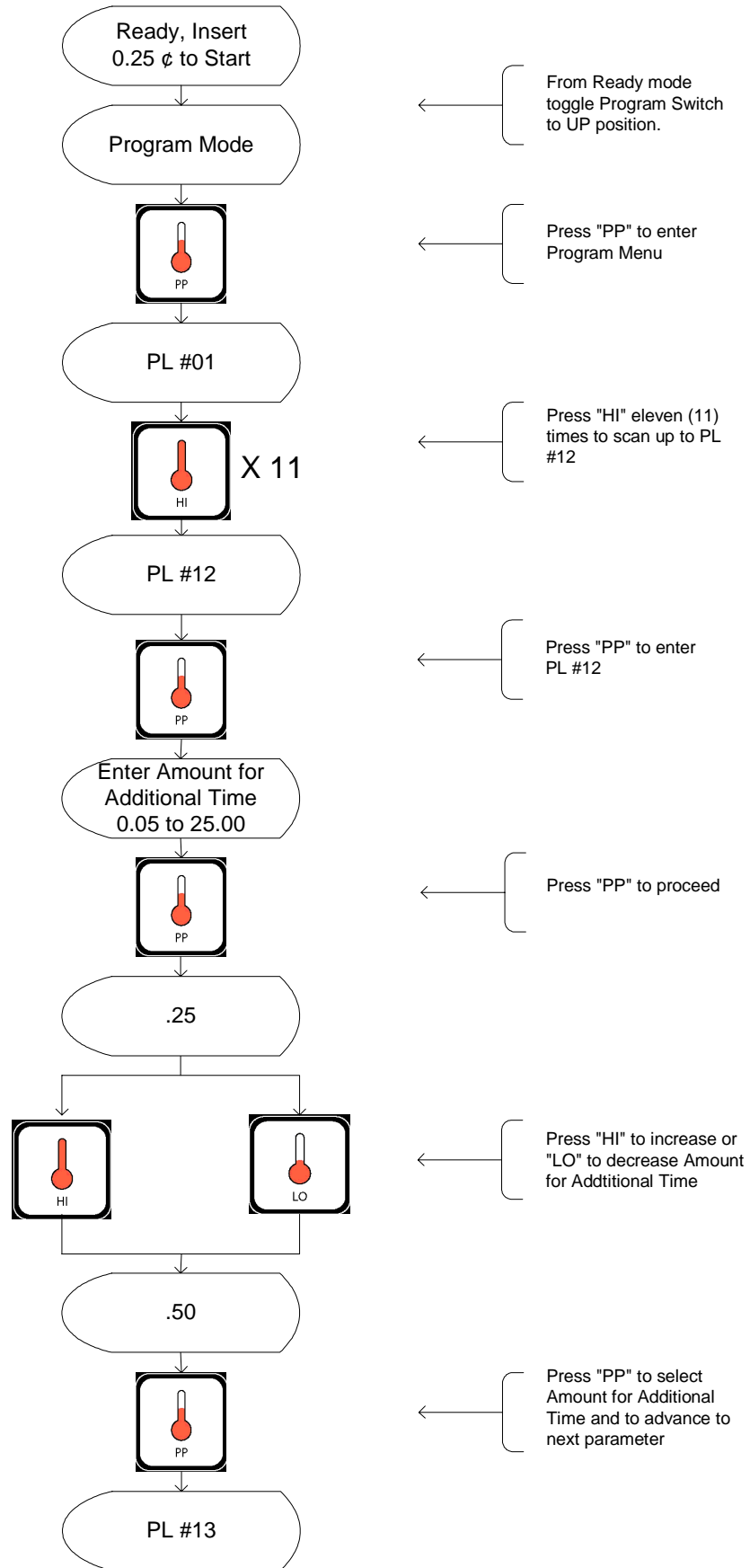

Setting Pre Purge Time

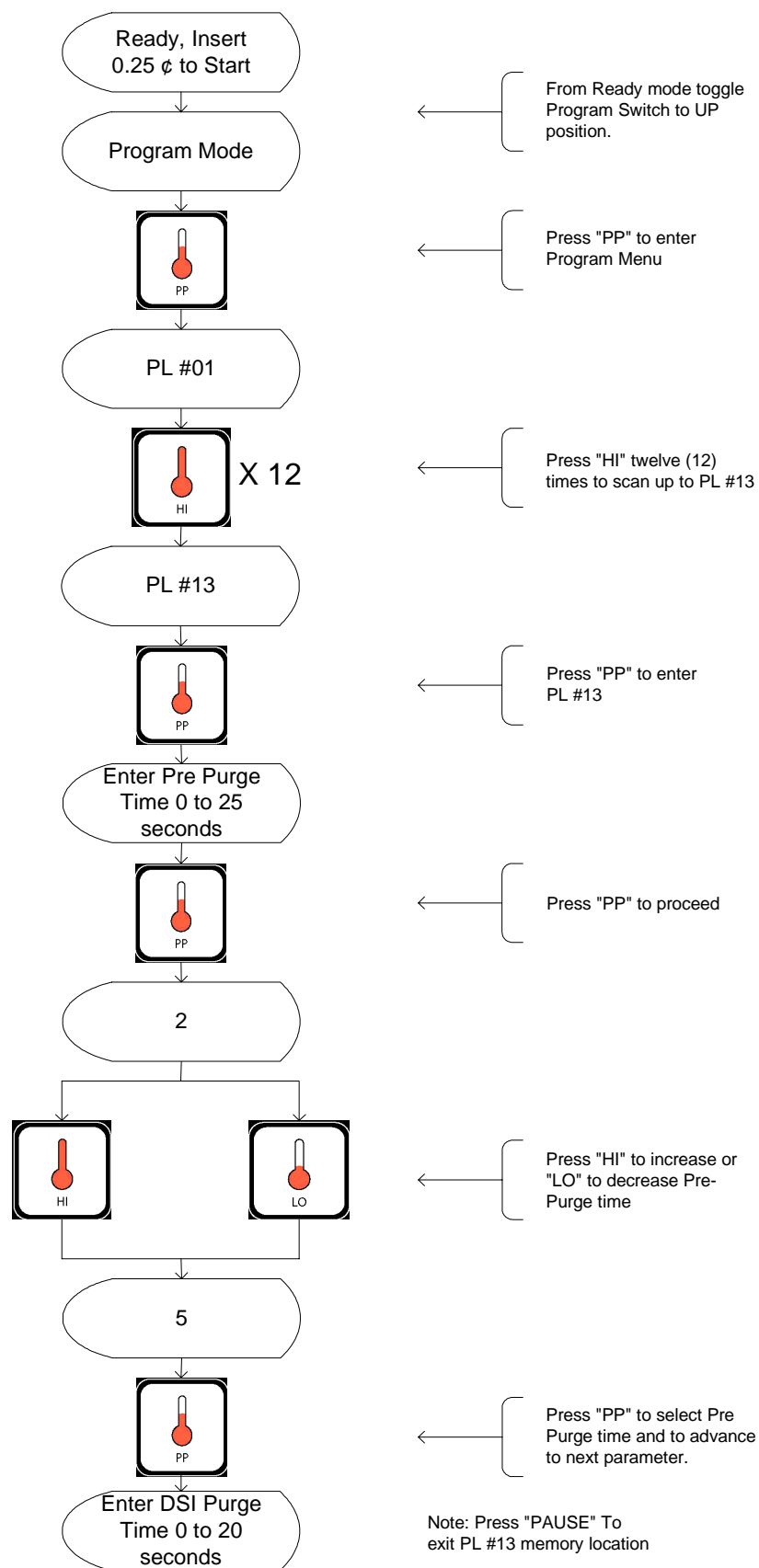

Setting DSI Purge Time

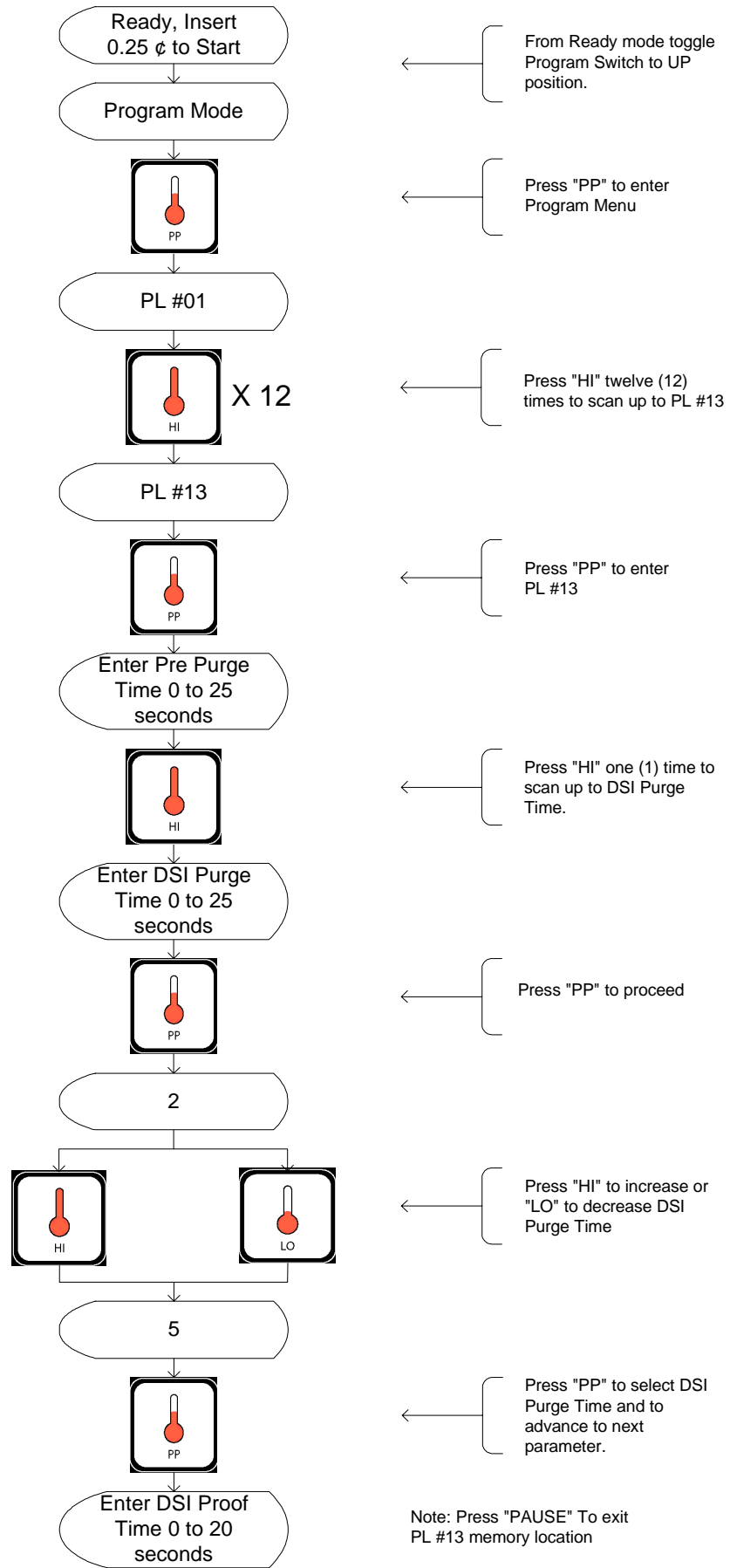

Setting DSI Proof Time

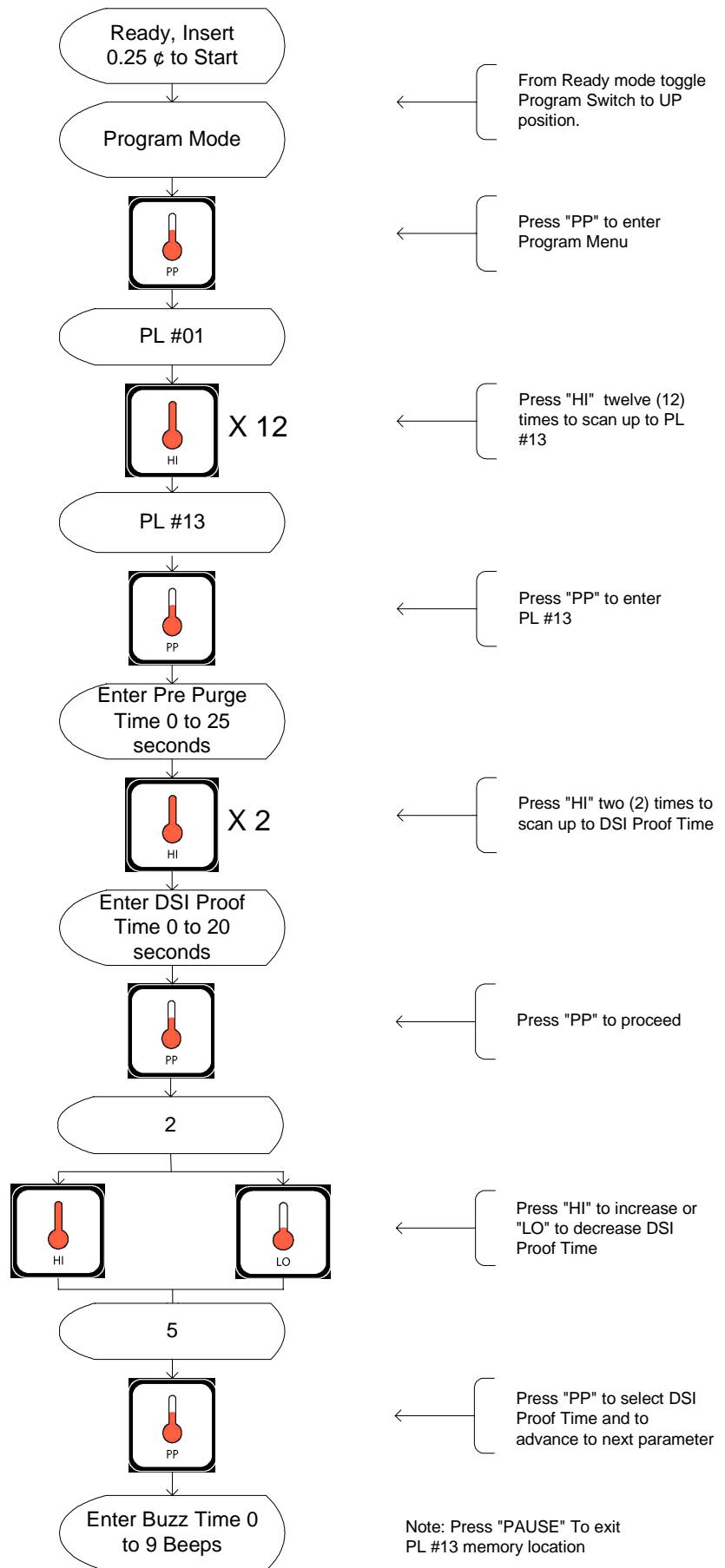

Setting Buzz Time

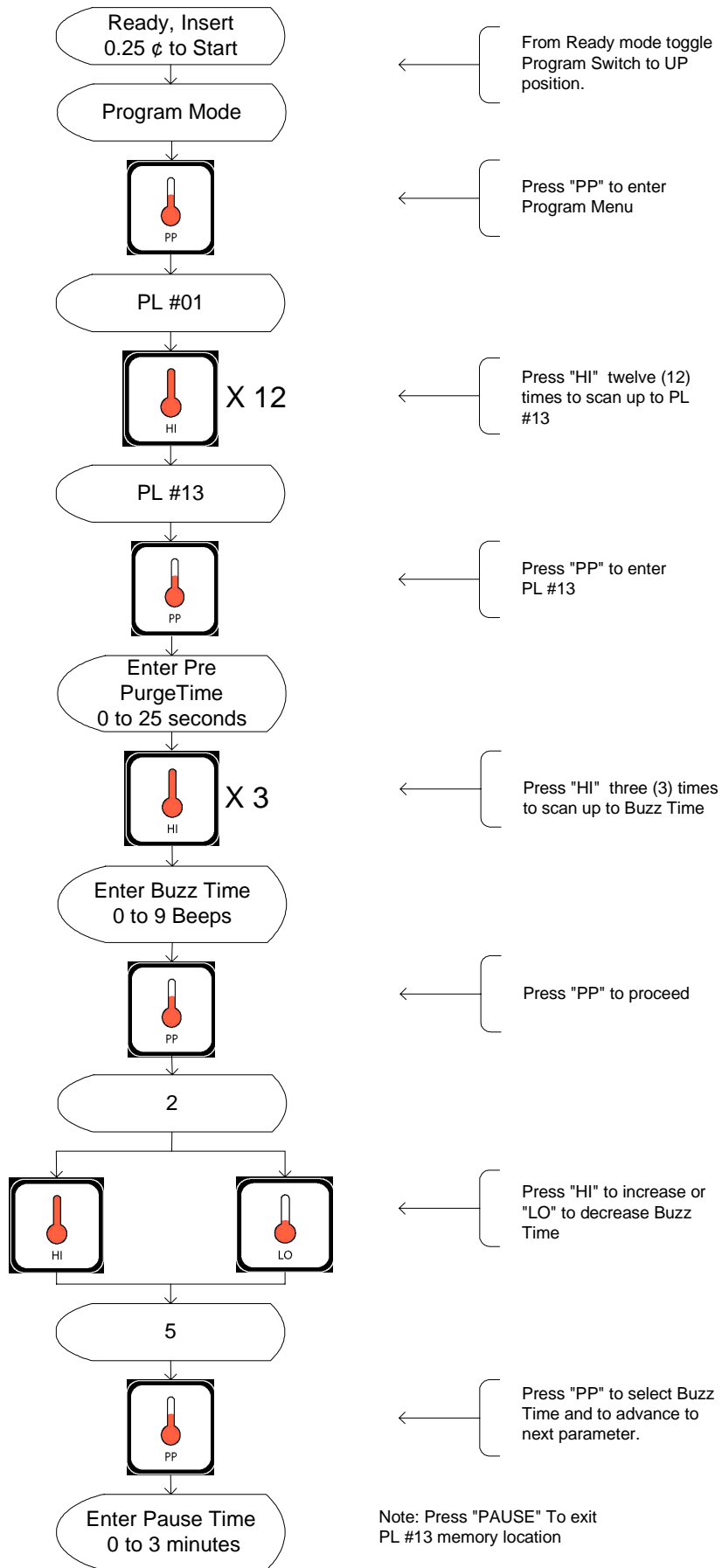

Setting Pause Time

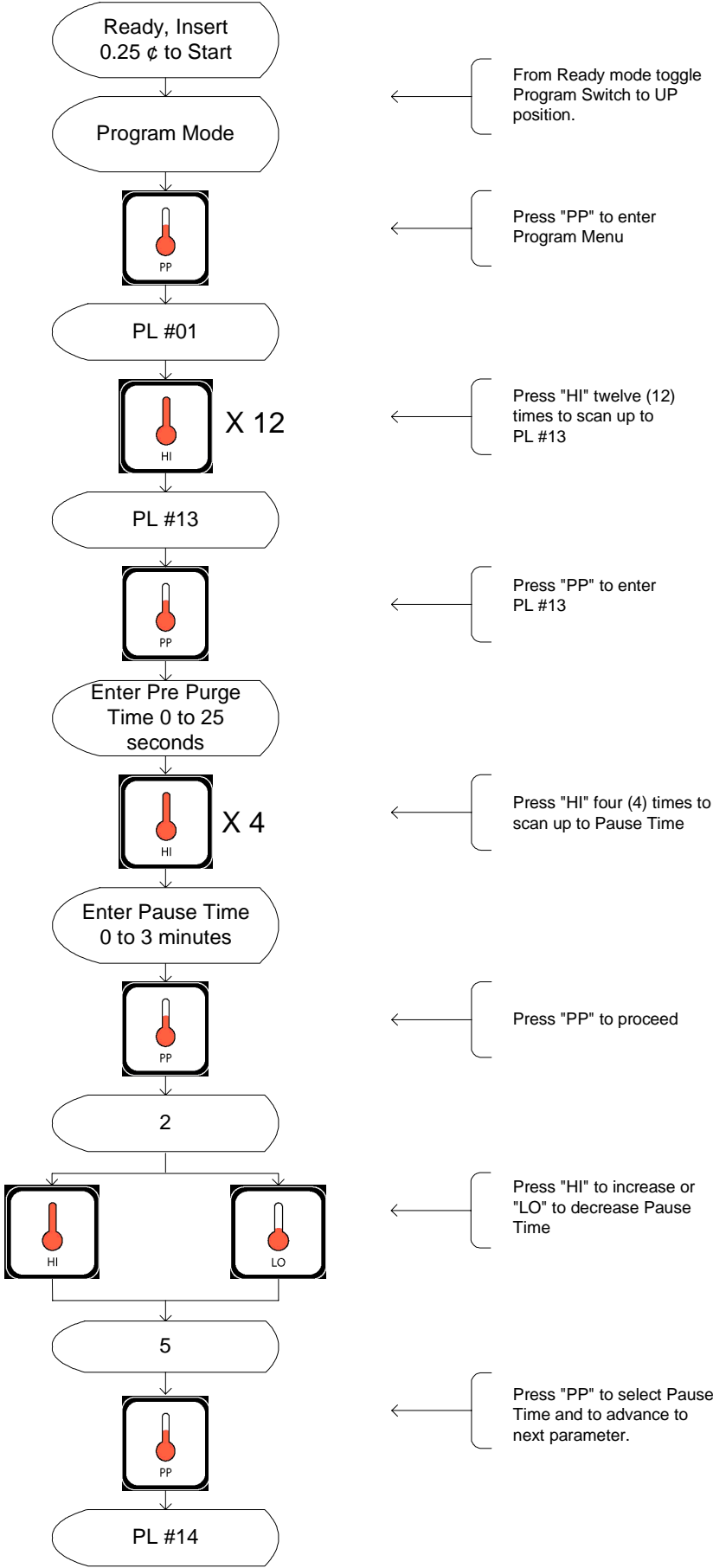

Setting Lint Cleaning Frequency

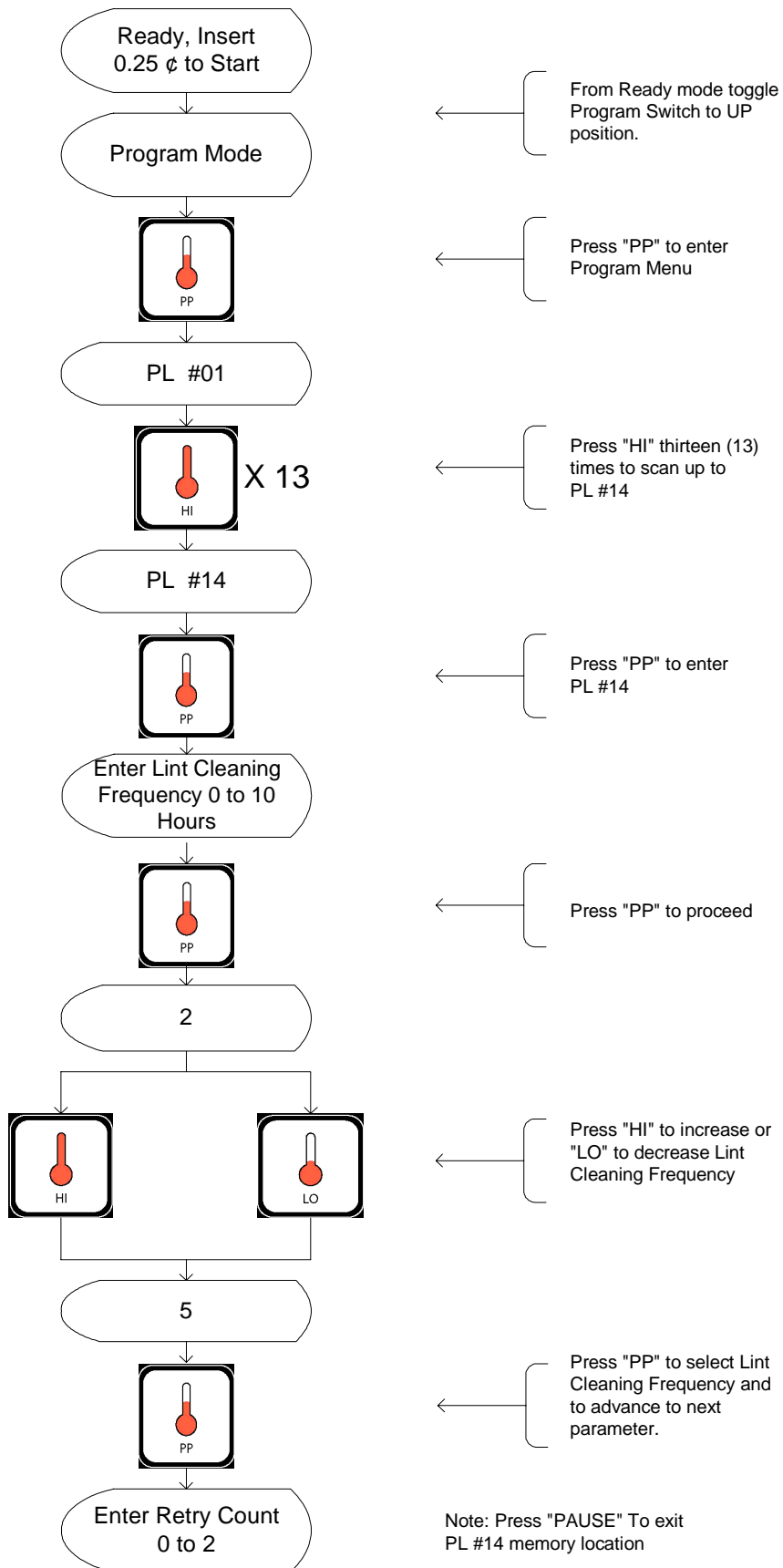

Setting Retry Count

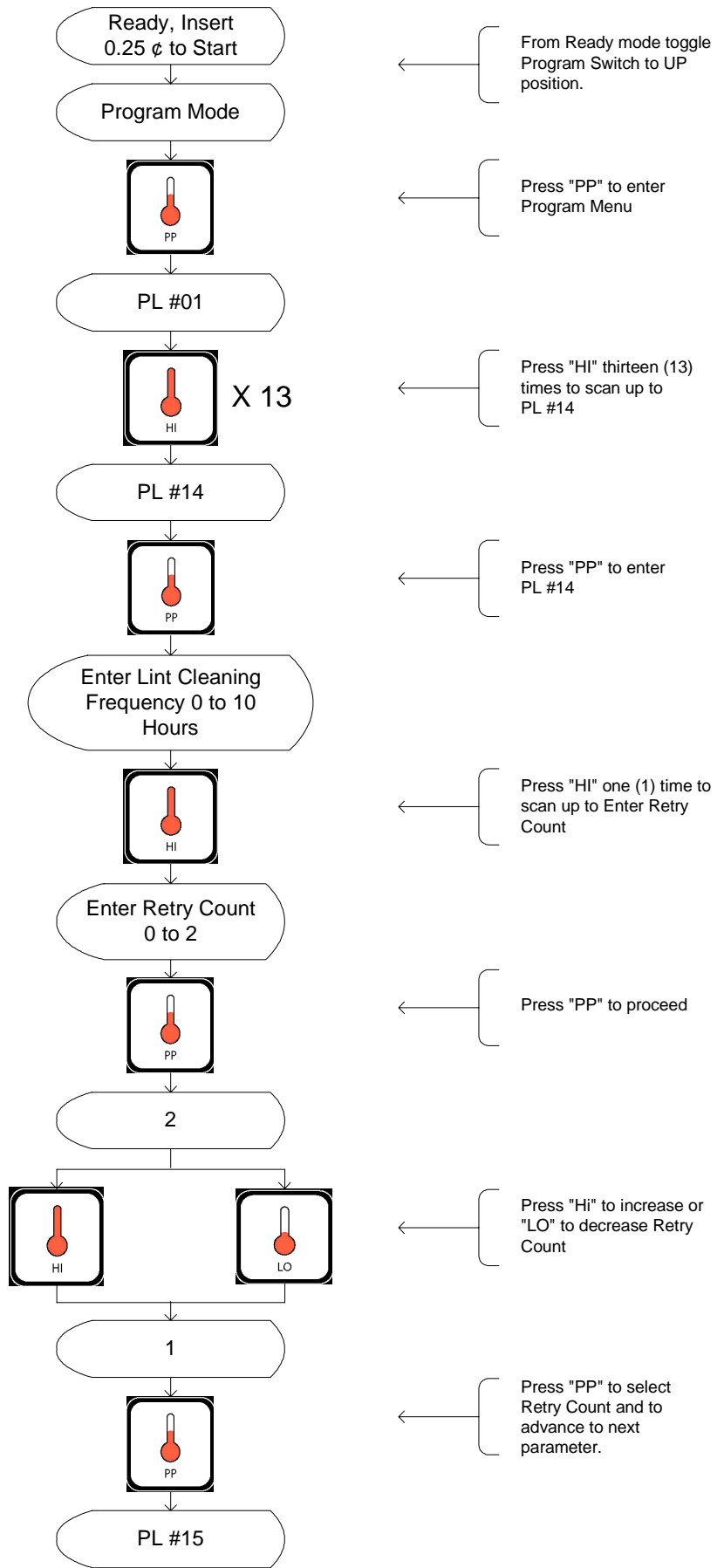

Clearing Credit

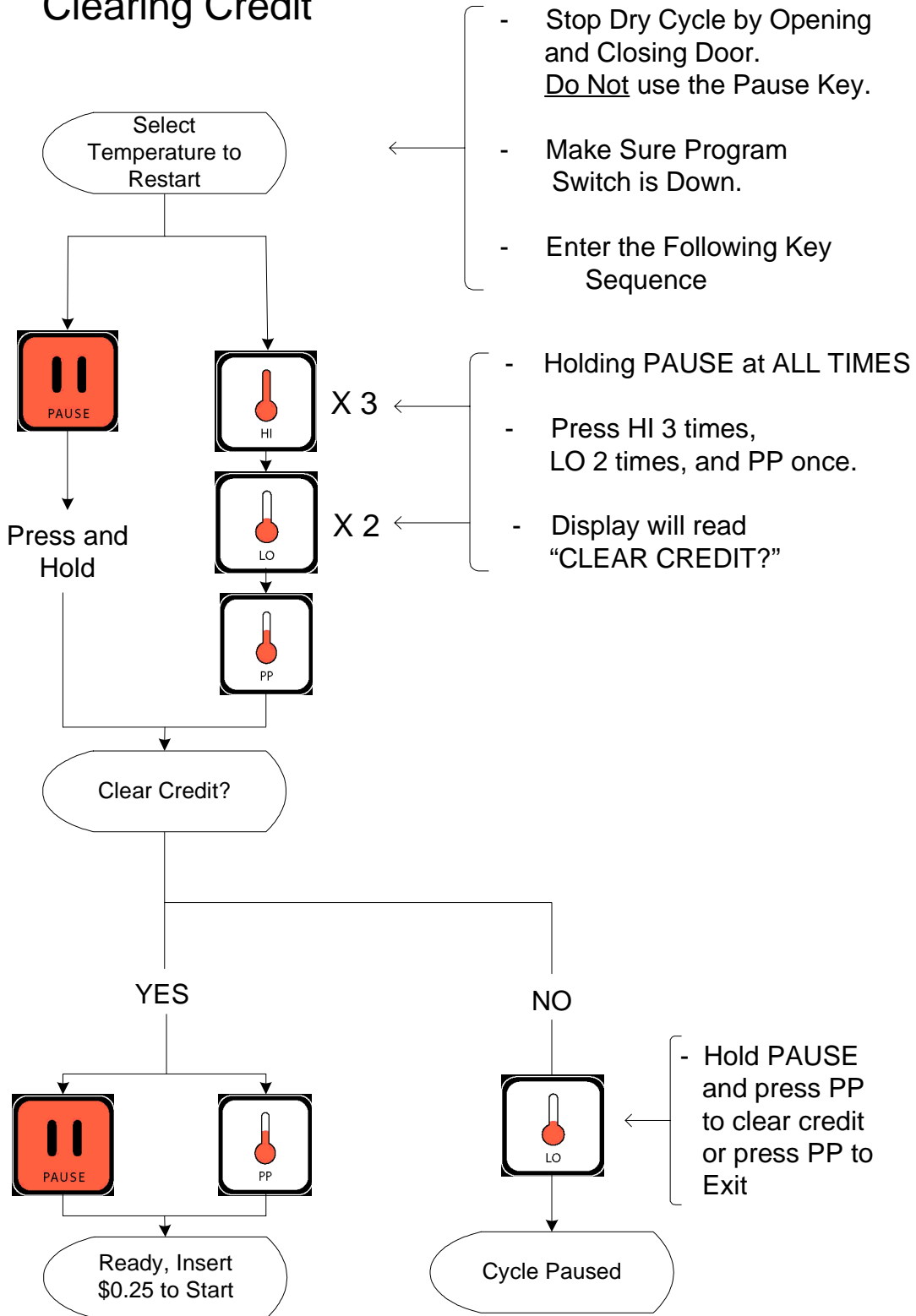

Accessing and Clearing Coin Vault Total

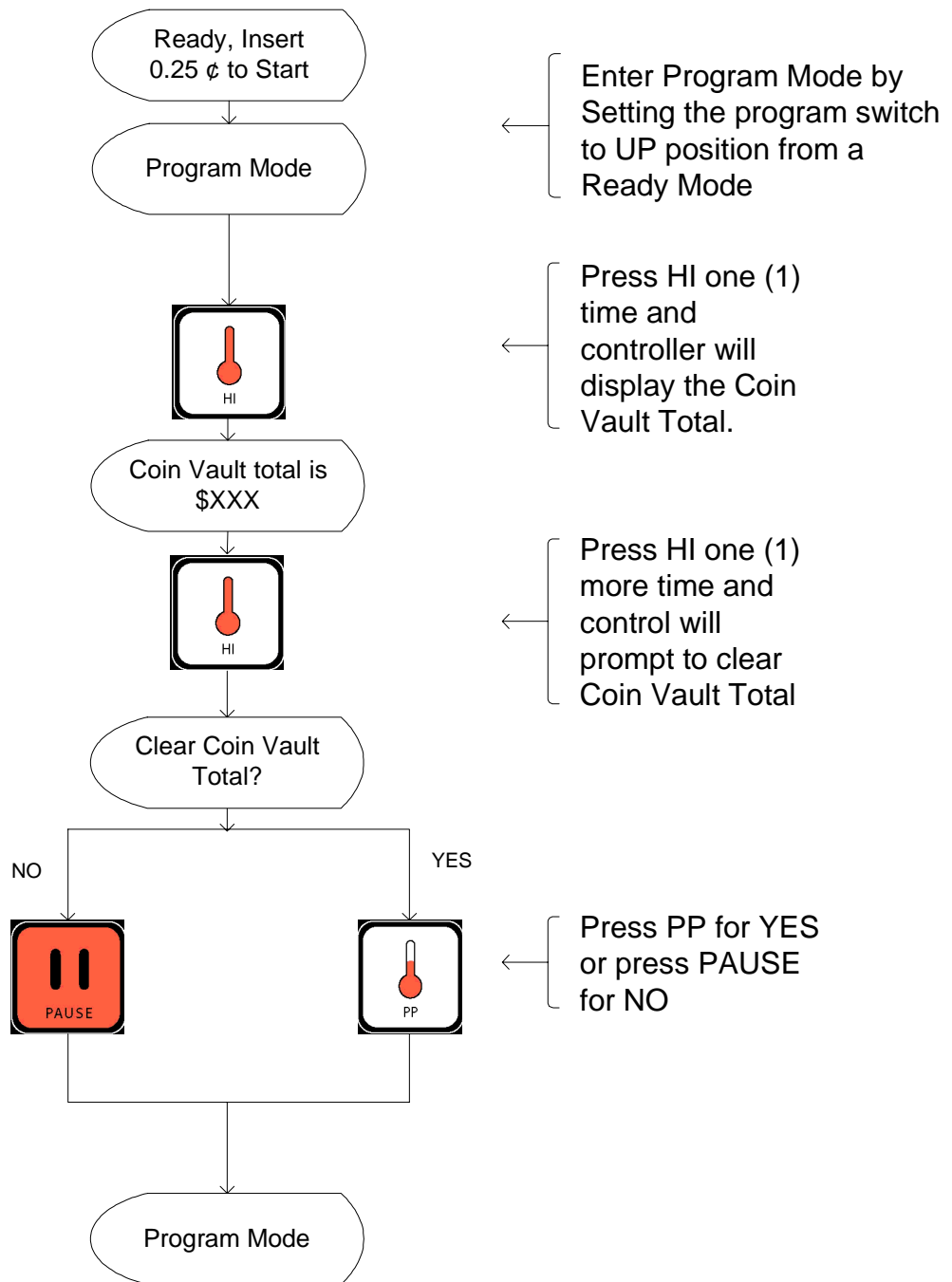

SECTION VII

FACTORY PRESETS

		Factory Defaults
PL01	Select Language	English
	Select Currency	USD
	Select Model	Gas Single Motor
	Select Temp Scale	Fahrenheit
	Select Buzzer Mode	Buzz
	Select Dry Mode	Coin
	Select Vending Safeguard	Bad Coin Reset
	Select Vending Mode	Acc. Time
Select Rotation Sensor	Active	
PL02	High Dry Temp	180
PL03	High Cool Temp	100
	High Cool Down Time	2 min
PL04	Low Dry Temp	120
PL05	Low Cool Temp	100
	Low Cool Down Time	2 min
PL06	PP Dry Temp	150
PL07	PP Cool Temp	100
	PP Cool Down Time	2 min
PL08	Left Coin Denomination	.25
PL09	Right Coin Denomination	.10
PL10	Time for Amount to Start	10 min
PL11	Amount to Start	.25
PL12	Amount for Additional Time	.25
PL13	Enter Pre –Purge Time	0
	Enter DSI Purge Time	3
	Enter DSI Proof Time	8
	Enter Buzz Time	5
	Enter Pause Time	1
PL14	Lint Cleaning Frequency	5
	Retry Count	2

SECTION VIII

PHASE 7 COIN SYSTEM DIAGNOSTICS

IMPORTANT: YOU MUST DISCONNECT AND LOCKOUT THE ELECTRIC SUPPLY AND THE GAS SUPPLY OR THE STEAM SUPPLY BEFORE ANY COVERS OR GUARDS ARE REMOVED FROM THE MACHINE TO ALLOW ACCESS FOR CLEANING, ADJUSTING, INSTALLATION, OR TESTING OF ANY EQUIPMENT PER OSHA (Occupational Safety and Health Administration) STANDARDS.

ALL major circuits, including door, microprocessor temperature sensor, heat and motor circuits are monitored. The Phase 7 coin microprocessor controller (computer) will inform the user, via the liquid crystal display (L.C.D.) of certain failure messages, along with light emitting diode (L.E.D.) indicators on the Inputs/Outputs (I/O) on the control board.

ERROR MESSAGES:

NOTE: Any error associated with the “Out of Order” message can be identified by pressing the “LO” key while in the “Out of Order” condition. If the “HI” key is pressed during this time, the remaining credit can be viewed. Any “Out of Order” message is immediately followed by a 3-second tone. If the fault has been corrected, holding the “PAUSE” key for 3-seconds will clear the fault message. If more than one fault occurred at the same time, after the first fault is cleared, the next fault **will be** displayed and will need to be cleared. This will occur until **ALL** faults have been displayed. In free mode, the control **will not** display “Out of Order;” it will just display the fault.

A. DIAGNOSTIC (L.C.D.) FAULT MESSAGES

MODEL FAULT - This routine monitors the inputs, such as the sail switch and gas valve. Steam dryers **DO NOT** use a sail switch or valve input, and an electric dryer will not use a valve input. These signals allow the controller to interpret what type of dryer it is controlling. The controller determines what the expected dryer responses **should be** for that specific heat type dryer.

NOTE: If a model error occurs, the microprocessor will always default to the “gas” type for safety reasons. Also, the dryer is stopped and forced into a restart condition to reevaluate **ALL** the expected responses.

SAIL SWITCH CLOSED FAULT - This routine prevents the startup of the dryer unless the sail switch is in the open position. If the sail switch is in the closed position prior to starting, the controller will display “Out of Order” for a “Sail Switch Closed Fault,” and the dryer will not be allowed to start. This routine is also monitored at every startup, including during the cycle. Anytime the fault occurs, there will be an audio indication and start/restart will be prevented.

SAIL SWITCH OPEN FAULT - If the sail switch does not close within 8-seconds of starting or restarting a cycle, the controller will display “Sail Switch Open Fault” condition. Or if the sail switch opens during a cycle the controller will immediately shut off the heat output and will monitor how long the sail switch is open for, if the sail switch is open for more than 30-seconds the controller will display “Sail Switch Open Fault” condition. If the basket (tumbler) temperature is above 100° F (38° C) the controller will continue to display “Open Sail Switch Fault” while the dryer cools by running with no heat for 2 minutes or until the temperature drops below 100° F (38° C). Once the basket (tumbler) temperature is below 100° F (38° C), the controller will shut off **ALL** outputs and will go into a fault mode with a brief audio indication

BURNER HIGH-LIMIT FAULT - This routine monitors the burner high-limit switch. If the switch opens during the cycle while the heat is on, the dryer will display “Burner High-Limit Fault.” The controller will check the basket (tumbler) temperature. If the exhaust probe temperature is above 100° F (38° C), the dryer will continue to display “Burner High Limit Fault” while the dryer cools by running with no heat for 2 minutes or until the temperature drops below 100° F (38° C). If the exhaust probe temperature is below 100° F (38° C) the controller will shut off **ALL** outputs and will go into a fault mode with a brief audio indication.

EXHAUST HIGH-LIMIT FAULT - This routine monitors the basket (tumbler) safety over temperature switch. If the switch opens, the dryer will display “Exhaust High Limit Fault.” If the basket (tumbler) temperature is above 100° F (38° C) the dryer will continue to display “Exhaust High Limit Fault” while the controller cools by running with no heat for 2 minutes or until the temperature drops below 100° F (38° C). If the basket (tumbler) temperature is below 100° F (38° C) the controller will shut off **ALL** outputs and will go into a fault mode with a brief audio indication.

BURNER IGNITION CONTROL - This routine monitors the ignition control and gas valve return signal in comparison to the direct spark ignition (DSI) purge time set in PL13. If the gas valve return signal from the ignition control has not turned on or has disengaged prior to the expiration of the DSI purge time set in PL13, the controller will interrupt the cycle and will display “Burner Ignition Control Fault” condition. If the basket (tumbler) temperature is above 100° F (38° C) the dryer will continue to display “Burner Ignition Control Fault” while the dryer cools by running with no heat for 2 minutes or until the temperature drops below 100° F (38° C). Once the basket (tumbler) temperature is below 100° F (38° C), the controller will shut off **ALL** outputs and will go into a fault mode with a brief audio indication.

IGNITION FAULT - After the controller receives a gas valve return signal within the DSI purge time, the controller will begin a DSI proof time. The controller will continue to recheck the gas valve return signal, if signal is lost during the DSI proof time, the controller will turn off the heat output and will determine what the retry count in PL14 is set at. If the retry count is greater than zero the controller will wait 20 seconds and will attempt to reignite the flame. If the failure condition occurs again the controller will retry until the retry count in PL14 has been satisfied. Once the retry count has been satisfied the controller will interrupt the cycle and will display “Ignition Fault” condition. If the basket (tumbler) temperature is above 100° F (38° C) the controller will continue to display “Ignition Fault” while the dryer cools by running with no heat for 2 minutes or until the temperature drops below 100° F (38° C). Once the basket (tumbler) temperature is below 100° F (38° C), the controller will shut off **ALL** outputs and will go into a fault mode with a brief audio indication.

FLAME FAULT - After the controller has verified that the gas valve signal was present through out the DSI purge time and the DSI proof time the controller will continue to monitor the gas valve return signal. In the event that the gas valve return signal is lost anytime after the DSI proof time the controller will turn off the heat output and will increment a counter. Once this fault condition occurs 5 consecutive times the controller will interrupt the cycle and will display “Flame Fault” condition. If the basket (tumbler) temperature is above 100° F (38° C) the controller will continue to display “Flame Fault” while the dryer cools by running with no heat for 2 minutes or until the temperature drops below 100° F (38° C). Once the basket (tumbler) temperature is below 100° F (38° C), the controller will shut off **ALL** outputs and will go into a fault mode with a brief audio indication.

CLEAN LINT - This routine monitors the opening of the lint drawer switch and compares the time between openings to the lint cleaning frequency set in PL14. This routine will first prompt the user to clean lint before locking out the dryer. Once the time between cleanings is equal to the setting in PL14, the display will prompt the user to clean lint. The lint cleaning frequency limits the amount of time the dryer will run before the microprocessor locks the dryer out for further use. Once the lint count is reached, the lint drawer **must be** opened for at least 3-seconds in order to reset the counter. If the lint drawer is not cleaned within 2 hours, the control will be locked out.

CHECK MAIN FUSE - This routine identifies the opening of the main fuse (fuse 2) on the Phase 7 control board. If the fuse has opened, the microprocessor will not allow a cycle to begin and will display “Check Main Fuse” condition. If coins are entered, the credit will be accumulated as it should, however, it will not be applicable to a cycle until the error has been corrected. If the fuse has opened after the cycle has begun, it will still trigger the check main fuse fault. The dryer will run with no heat for 2 minutes or until the basket (tumbler) temperature drops below 100° F (38° C). If the basket (tumbler) temperature is below 100° F (38° C) the controller will shut off **ALL** outputs and will go into a fault mode with a brief audio indication.

EXHAUST TEMPERATURE SENSOR FAULT/AXIAL TEMPERATURE SENSOR FAULT - This routine indicates a problem with the temperature sensor circuit. This error will trigger an “Exhaust Probe Fault or Axial Probe Fault” condition. The dryer will run with no heat for 2 minutes or until the basket (tumbler) temperature drops below 100° F (38° C). If the basket (tumbler) temperature is below 100° F (38° C), the controller will shut off **ALL** outputs and will go into a fault mode with a brief audio indication.

ROTATIONAL SENSOR FAULT - This routine monitors the pulses from the rotational sensor input. It basically times the dwell between the signals. If the time between the pulses exceeds 8-seconds, the controller will trigger a “Rotate Sensor Fault” condition. The dryer will run with no heat for 2 minutes or until the temperature drops below 100° F (38° C). If the basket (tumbler) temperature is below 100° F (38° C) the controller will shut off **ALL** outputs and will go into a fault mode with a brief audio indication.

EXHAUST HIGH TEMP FAULT - This error routine indicates a problem with overheating. This error will initiate an “Exhaust High Temp Fault” condition. The controller determines this error by monitoring the temperature sensor input to have a steady gradual increase in temperature to a known upper limit (the limit typically is 20° over the maximum allowed programmable set point). The controller will disengage **ALL** outputs and will go into a fault mode with a brief audio indication.

B. SENSOR ACTIVATED FIRE EXTINGUISHING (S.A.F.E.) SYSTEM MESSAGES

1. DIAGNOSTIC MESSAGES:

When “S.A.F.E. System Disabled...” is displayed the specific cause can be viewed by pressing “PAUSE” and “LO” together.

OPEN S.A.F.E. SYSTEM PROBE FAULT - This message indicates that the S.A.F.E. system probe is either not connected or is damaged.

SHORTED S.A.F.E. SYSTEM PROBE FAULT - This indicates that the S.A.F.E. system probe is shorted or the wire to the S.A.F.E. system probe is shorted.

OPEN S.A.F.E. SYSTEM VALVE FAULT - This indicates that the water valve is open or that it is not connected to the control.

SHORTED S.A.F.E. SYSTEM VALVE FAULT - This indicates a problem with the water valve where it has been shorted out.

WATER NOT CONNECTED - This indicates that there is no water pressure at the water valve. This will occur if water is not connected to the dryer or if there is low water pressure in the water line coming to the dryer.

2. ACTIVATION MESSAGE:

S.A.F.E. SYSTEM ACTIVATED OR S.A.F.E. SYSTEM WAS ACTIVATED - This indicates that the S.A.F.E. system is on. If the S.A.F.E. system is active, the buzzer will be sounded at a fast pace and the controller will display “S.A.F.E. System Activated.” Once the S.A.F.E. system is deactivated, the controller will display “S.A.F.E. System was Active” until the dryer is attended to by someone.

C. INPUT/OUTPUT (I/O) BOARD LIGHT EMITTING DIODE (L.E.D.) INDICATORS

1. INPUTS

H2O – (RED L.E.D.)	This L.E.D. will indicate the status of the water pressure sensor. If the water pressure is present, the L.E.D. <u>will be</u> ON.
LINT – (RED L.E.D.)	This L.E.D. will indicate the status of the lint drawer. If the drawer is closed, then the L.E.D. is ON.
MAIN – (RED L.E.D.)	This L.E.D. will indicate the status of the main door. If the door is closed, then the L.E.D. is ON.
EXHL – (RED L.E.D.)	This L.E.D. will indicate the status of the exhaust high limit disk. If the disk is closed (temperature below 225° F [107° C]), then the L.E.D. is ON.
SAIL – (RED L.E.D.)	This L.E.D. will indicate the status of the sail switch. If the switch is closed, then the L.E.D. is ON.
BRHL – (RED L.E.D.)	This L.E.D. will indicate the status of the burner high limit disk. If the disk is closed (temperature below 330° F [166° C]), then the L.E.D. is ON.
GAS_V – (RED L.E.D.)	This L.E.D. will indicate the status of the gas valve. If the gas valve is open (ON), then the L.E.D. is ON.

2. OUTPUTS

DRIVE – (GREEN L.E.D.)	This L.E.D. will indicate the status of the basket (tumbler) forward direction output. If the request to tumble the basket (tumbler) in the forward direction is made, then the L.E.D. is ON.
FAN – (GREEN L.E.D.)	This L.E.D. will indicate the status of the fan output. If the request to turn on the fan (blower) is made, then the L.E.D. is ON.
HEAT – (GREEN L.E.D.)	This L.E.D. will indicate the status of the heat output. If the request to turn on the heater is made, then the L.E.D. is ON.
FSS – (GREEN L.E.D.)	This L.E.D. will indicate that the S.A.F.E. system is active.

D. KEYBOARD (TOUCH PAD) LAYOUT

1. Liquid Crystal Display
2. HI Button
3. PERMANENT PRESS Button
4. LO Button
5. PAUSE Button

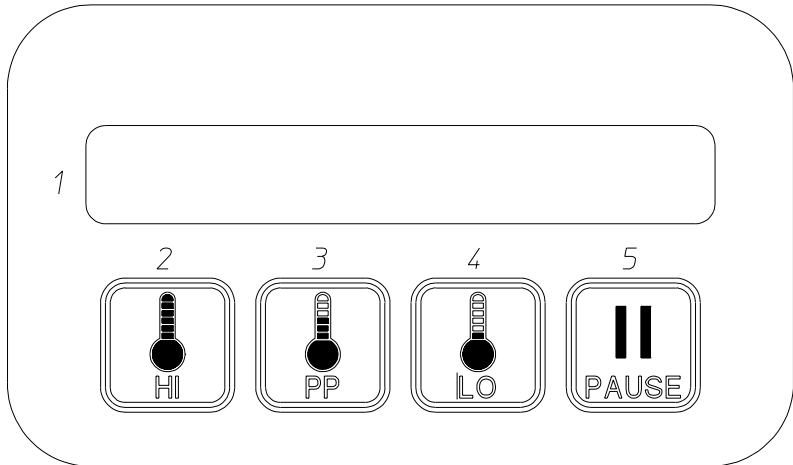

MAN6219

JM 8/1/02

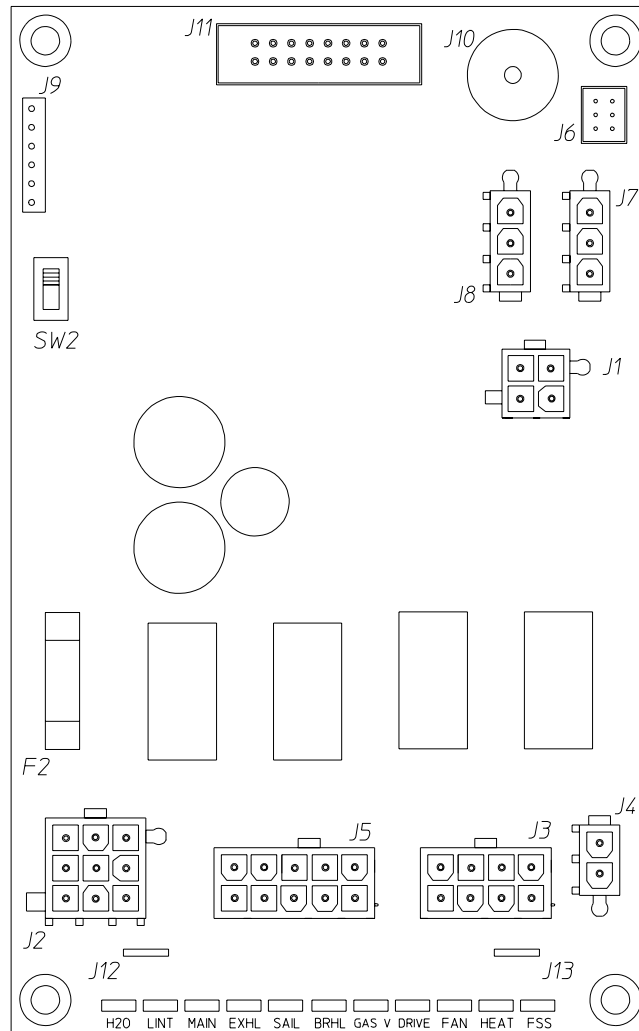

MAN6220

JM 8/1/02

ADC 113319

1 - 09/10/02-50
4 - 10/17/02-250
7 * 06/12/03-25

2 - 09/11/02-50
5 * 01/02/03-300

3 - 09/16/02-100
6 - 05/30/03-25

